



FINAL REPORT

AIC 22-1002

Niugini Aviation Services Limited

P2-BWC

PAC 750XL

Landing Gear Collapse during Landing Roll

Tekin Airstrip, Sandaun Province

PAPUA NEW GUINEA

26 January 2022



Intentionally Left Blank

About the AIC

The Accident Investigation Commission (AIC) is an independent statutory agency within Papua New Guinea (PNG). The AIC is governed by a Commission and is entirely separate from the judiciary, transport regulators, policy makers and service providers. The AIC's function is to improve safety and public confidence in the aviation mode of transport through excellence in: independent investigation of aviation accidents and other safety occurrences within the aviation system; safety data recording and analysis; and fostering safety awareness, knowledge and action.

The AIC is responsible for investigating accidents and other transport safety matters involving civil aviation in PNG, as well as participating in overseas investigations involving PNG registered aircraft. A primary concern is the safety of commercial transport, with particular regard to fare-paying passenger operations.

The AIC performs its functions in accordance with the provisions of the *PNG Civil Aviation Act 2000 (As Amended)*, and the *Commissions of Inquiry Act 1951*, and in accordance with *Annex 13* to the *Convention on International Civil Aviation*.

The objective of a safety investigation is to identify and reduce safety-related risk. AIC investigations determine and communicate the safety factors related to the transport safety matter being investigated.

It is not a function of the AIC to apportion blame or determine liability. At the same time, an investigation report must include relevant factual material of sufficient weight to support the analysis and findings. At all times the AIC endeavours to balance the use of material that could imply adverse comment with the need to properly explain what happened, and why it happened, in a fair and unbiased manner.

Intentionally Left Blank

About this Report

On 26 January 2022 at 10:13 local time (00:13 UTC), the AIC was notified by Niugini Aviation Service Limited (NASL) via phone call of an accident involving a PAC 750XL aircraft, registered P2-BWC, owned and operated by NASL at Tekin Airstrip, Sandaun Province. The AIC immediately commenced an investigation.

This Accident Final Report has been produced by the PNG AIC pursuant to *ICAO Annex 13, Chapter 6, paragraph 6.5* and has been approved for public release.

The report is based on the investigation carried out by the AIC under the Papua New Guinea *Civil Aviation Act 2000 (As Amended)*, and *Annex 13* to the *Convention on International Civil Aviation*. It contains information, analysis of that information, findings and contributing (causal) factors, other factors, safety actions, and safety recommendations.

Although AIC investigations explore the areas surrounding an occurrence, only those facts that are relevant to understanding how and why the accident occurred are included in the report. The report may also contain other non-contributing factors which have been identified as safety deficiencies for the purpose of improving safety.

Readers are advised that in accordance with *Annex 13* to the *Convention on International Civil Aviation*, it is not the purpose of an AIC aircraft accident investigation to apportion blame or liability. The sole objective of the investigation and the final report is the prevention of accidents and incidents (Reference: *ICAO Annex 13, Chapter 3, paragraph 3.1*). Consequently, AIC reports are confined to matters of safety significance and may be misleading if used for any other purpose.



Capt. Aria Bouraga, MBE

Acting Chief Commissioner

10 January 2023

Intentionally Left Blank

TABLE OF CONTENTS

TABLE OF CONTENTS	vi
FIGURES.....	ix
TABLES.....	x
GLOSSARY OF ABBREVIATION.....	xi
INTRODUCTION	xii
1 FACTUAL INFORMATION.....	1
1.1 History of the flight.....	1
1.2 Injuries to persons	3
1.3 Damage to aircraft.....	3
1.4 Other damage	3
1.5 Personnel information	4
1.5.1 Pilot.....	4
1.6 Aircraft Information.....	4
1.6.1 Aircraft data	4
1.6.2 Weight and Balance	5
1.6.3 Minimum Equipment List.....	6
1.6.4 Main Landing Gear System	6
1.6.5 Collision Avoidance Systems	8
1.7 Meteorological information	8
1.7.1 PNG National Weather Service Forecast Data	8
1.7.2 Tekin Local Weather.....	8
1.8 Aids to navigation	9
1.9 Communication.....	9
1.10 Aerodrome information	10
1.10.1 On-site observation of Tekin Airstrip	11
1.11 Flight recorders	12
1.12 Wreckage and impact information.....	12
1.12.1 Overview of the wreckage distribution.....	12
1.12.2 Damage and wreckage Inspection.....	12
1.13 Medical and pathological information	14
1.14 Fire.....	14
1.15 Survival aspects	14
1.15.1 Search and Rescue	14
1.15.2 Emergency Locator Transmitter	15

1.16	. Tests and Research.....	15
1.16.2	Disassembling left MLG.....	16
1.17	Organisational and Management Information	18
1.17.1	Niugini Aviation Services Limited (NASL)	18
1.17.2	Civil Aviation Safety Authority of PNG (CASA PNG) ...	21
1.18	Additional information.....	22
1.18.1	NASL Change Management Process	22
1.18.2	Tekin Airstrip Survey Report.....	23
1.18.3	Rural Airstrip Agency (RAA).....	23
1.18.4	Maintenance Manual Supplements (MMS) 750XL	24
1.18.5	Visual Illusions	25
1.18.6	A PAC 750XL Aircraft Accident in Tekin on 10 January 2022.....	25
1.18.7	Occurrences involving rural airstrips from 2010 to 2022 .	25
1.19	Useful or effective investigation techniques.....	26
2	ANALYSIS	27
2.1	General.....	27
2.1.1	Flight Operation	27
2.1.2	Tekin Airstrip.....	28
2.1.3	Organisational	29
2.1.4	Calibrated Tools and Equipment.....	30
2.2	Search and Rescue	31
3	CONCLUSIONS	32
3.1	Findings	32
3.1.1	Aircraft.....	32
3.1.2	Pilot.....	32
3.1.3	Flight operations	32
3.1.4	Operator	32
3.1.5	Airstrip	33
3.1.6	Air Traffic services and airport facilities	33
3.1.7	Flight Recorders	33
3.1.8	Medical	33
3.1.9	Survivability.....	33
3.1.10	Safety Oversight.....	33
3.2	Causes [Contributing factors]	33
3.3	Other factors	33
4	RECOMMENDATIONS.....	35
4.1	Recommendations.....	35

4.1.1	Recommendation number AIC 22-R01/22-1002 to CASA PNG.....	35
4.1.2	Recommendation number AIC 22-R02/22-1002 to CASA PNG.....	35
4.1.3	Recommendation number AIC 22-R03/22-1002 to Sandaun Provincial Government.....	35
4.1.4	Recommendation number AIC 22-R09/22-1001 to Minister for Transport and Civil Aviation.	35
5	APPENDICES	37
5.1	Appendix A: Service Bulletin PACSB/XL/105 Issue 4.....	37
5.2	Appendix B: MLG Oleo Servicing	46
5.3	Appendix C: Maintenance on MLG.....	47
5.4	Appendix D: CASA PNG AC 139-6	50
5.5	Appendix E: NASL’s approved Process for Calibration of Tools and Equipment.....	52
5.6	Appendix F: Tekin Airstrip Survey	53
5.7	Appendix G: Maintenance Manual Supplement	55
5.8	Appendix H. Accidents at rural airstrips and the geographical locations of the airstrips.....	65

FIGURES

Figure 1. Depiction of P2-BWC flight path	1
Figure 2. Circuit area at Tekin Airstrip	2
Figure 3. Damage caused to P2-BWE by P2-BWC.	3
Figure 4. MLG and hardware fittings.	6
Figure 5. MLG Oleo Strut.	7
Figure 6. Reported downdraft area.	9
Figure 7. Tekin area Topography	10
Figure 8. Localise Wind Pattern at Tekin Airstrip	11
Figure 9. Observation at Tekin Airstrip.....	11
Figure 10. Landing mark on the strip.	12
Figure 11. Damage to the aircraft structure.	13
Figure 12. Damaged sustained on the left MLG.....	13
Figure 13. Damage sustained on the attachment brackets and bolts	14
Figure 14. Left MLG prior to disassembling.....	15
Figure 15. Left MLG attachment fasteners.	16
Figure 16. Observations on the MLG oleo strut.	17
Figure 17. Observations on the Bearing and O-rings.	18
Figure 18. Left, Nitrogen Regulator and Right, Tyre Inflator.	19
Figure 19. Upslope and downslope visual illusions. (Source: FAA PHAK, Figure 17-7).....	25
Figure 20. Rural Airstrip accidents per year.....	26
Figure 21. Accidents at rural airstrips and the geographical locations of the airstrips	26

TABLES

Table 1: Injuries to persons	3
Table 2. PNG Airstrip Guide.....	10
Table 3. PNG Airstrip guide used by Operator for Tekin Airstrip.....	21
Table 4. RAA survey data for Tekin Airstrip.....	23

GLOSSARY OF ABBREVIATION

ATS	: Air Traffic Service
CPL A	: Commercial pilot license Aeroplane
CVR	: Cockpit voice recorder
ELT	: Emergency locator transmitter
ERP	: Emergency response plan
ETA	: Estimated time of arrival/Estimating arrival
FDR	: Flight data recorder
FM	: Flight Manual
Ft	: Foot (feet)
H	: Hour(s)
HF	: High frequency (3 000 to 30 000 kHz)
HPa	: Hectopascal
Kt	: Knot(s)
M	: Metre(s)
MEL	: Minimum equipment list
MHz	: Megahertz
Nm	: Nautical miles
RPM	: Revolutions per minute
SMS	: Safety management system
SOP	: Standard operating procedure(s)
UTC	: Coordinated Universal Time
VFR	: Visual flight rules
VHF	: Very high frequency (30 to 300 MHz)

INTRODUCTION

SYNOPSIS

On 26 January 2022, at about 9:43 local time (23:43 UTC) a PAC 750XL aircraft, registered P2-BWC, owned and operated by Niugini Aviation Services Limited while on a VFR charter flight from Kiunga Airport, Western Province to Tekin Airstrip, Sandaun Province, Papua New Guinea, during the landing roll aircraft sustained a left main landing gear assembly collapse and subsequent runway excursion.

There were seven persons onboard: one pilot and six passengers. At 09:06, P2-BWC departed Kiunga Airport and arrived at Tekin circuit area at 09:40.

The pilot established the aircraft on the final approach profile, he configured the aircraft for landing by fully extending the flaps and maintained an airspeed of about 80 knots (kts). The pilot also stated that he experienced a downdraft prior to touch down.

The aircraft landed at 09:43 with an airspeed of 75 knots as recalled by the pilot.

The aircraft touched down about 3m short of the airstrip edge boundary. The investigation determined that due to reduced damping effect of the oleo and/or the tyre of the left main landing gear, the landing gear attachment bolts sustained significant impact stress from the landing impact force and snapped, causing the gear assembly to collapse and separate from the aircraft. Subsequently, the left wing abruptly dropped, and the aircraft began veering to the left, towards the eastern edge of the airstrip.

The aircraft continued veering to the left and subsequently the left wingtip struck the outer edge of the extended right-hand flap of P2-BWE, a wreckage of the same aircraft type owned and operated by NASL that was involved in a similar accident on 18 January 2022, causing P2-BWC to abruptly veer further left and skid across the airstrip boundary as the nose-wheel and right main wheel bogged into the ground.

The pilot immediately shut down the engine and evacuated the passengers with the assistance of one of the Operator's personnel who was also a passenger on board. There were no reported injuries and the aircraft sustained significant damage.

Intentionally Left Blank

1 FACTUAL INFORMATION

1.1 History of the flight

On 26 January 2022, at 9:43 local (23:43 UTC¹) a PAC 750XL aircraft, registered P2-BWC, owned and operated by Niugini Aviation Services Limited (NASL) was conducting a single pilot VFR² charter flight from Kiunga Airport, Western Province to Tekin Airstrip, Sandaun Province, Papua New Guinea, when during the landing roll, the aircraft sustained a left Main Landing Gear (MLG) assembly collapse and subsequent runway excursion.

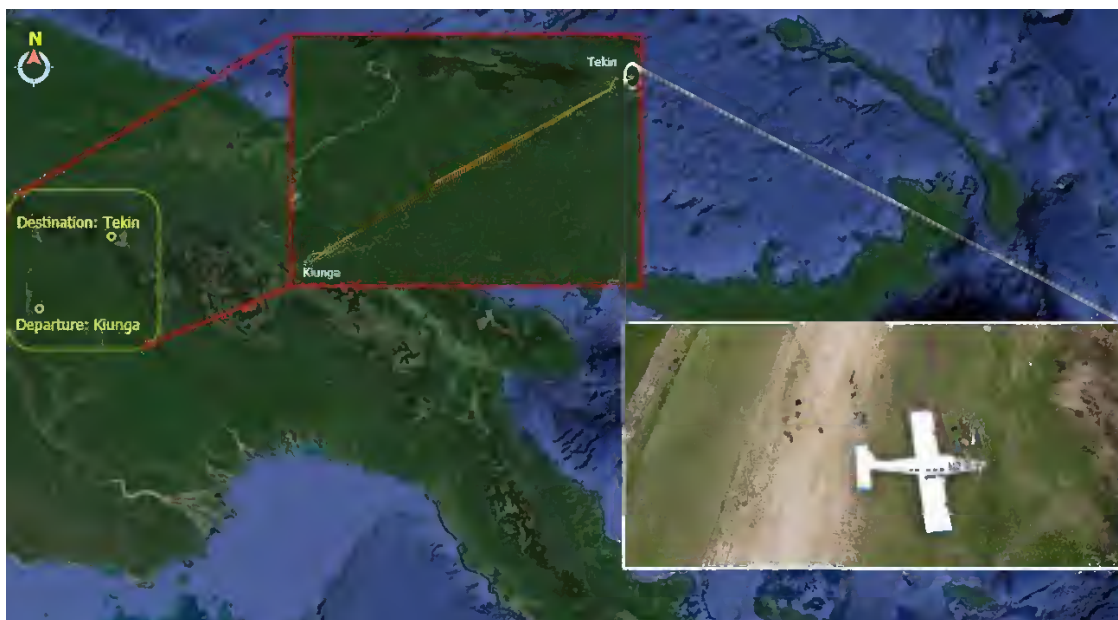

Figure 1. Depiction of P2-BWC flight path

There were seven persons onboard: one pilot and six passengers. According to the Air Traffic Services (ATS) data, at 09:06, P2-BWC departed Kiunga Airport and reported an estimated arrival time for Tekin Airstrip at 09:37.

The Spidertracks³ recorded data showed that after departure from Kiunga Airport, the aircraft climbed to an altitude of about 10,000 ft AMSL⁴ and began tracking Northeast of Kiunga for Tekin.

At 09:26, about 34 NM from Tekin, the pilot called ATS and revised the estimated arrival time to 09:41. The pilot subsequently informed ATS that he would call after landing in Tekin.

According to the Spidertracks, at 9:40 the aircraft arrived in the Tekin circuit area and entered a gradual descent as it tracked over the airstrip. The aircraft was positioned overhead the airstrip at about 2,000 ft AGL⁵. During an interview with the AIC, the pilot stated that while flying overhead, he conducted an aerial inspection and observed that the airstrip was suitable for landing.

¹ The 24-hour clock, in Coordinated Universal Time (UTC), is used in this report to describe the local time as specific events occurred. Local time in the area of the serious incident, Papua New Guinea Time (Pacific/Port Moresby Time) is UTC +10 hours.

² Visual Flight Rules

³ Tracking system that transmits a combination of parameters (such as location, time, altitude, speed, rate of climb, heading and distance) back to the website and mobile application for real-time viewing by end users. It transmits data every 12 seconds.

⁴ Above Mean Sea Level

⁵ Above Ground level (AGL). All altitude data obtained from the Spidertracks recorded data are referenced to the Tekin Airstrip threshold elevation of 5,632 ft

Spidertracks data showed that the aircraft tracked towards the Northeast of the airstrip. At about 2NM Northeast of the airstrip, the pilot turned left base for approach. The aircraft established on final approach profile about 1 NM from the airstrip 400 ft AGL. During interview with the AIC, the pilot stated that once the aircraft was established on the final approach profile, he configured the aircraft for landing by fully extending the flaps and maintained an airspeed of about 80 knots (kts). The pilot also stated that he experienced a downdraft⁶ prior to touch down.



Figure 2. Circuit area at Tekin Airstrip

Spidertracks data showed that the aircraft landed at 09:43. The pilot recalled the touchdown speed was about 75 kts.

During an interview with AIC, the pilot stated that following touchdown, he recalled noticing the left wing abruptly dropping and the aircraft begin to veer left, towards the eastern edge (boundary) of the airstrip. The pilot added that he applied full right rudder to maneuver the aircraft back to the right to maintain the runway centreline and to avoid collision with another PAC 750XL aircraft⁷. However, the aircraft continued veering left. The pilot further added that he set the condition lever to ground idle and retracted the flaps.

As the aircraft rolled towards the edge, the aircraft’s left wingtip struck the outer edge of the extended right-hand flap of P2-BWE, causing the aircraft to abruptly veer further left and skid across the airstrip boundary as the nose-wheel and right main wheel bogged into the ground. The aircraft came to rest about 13m to the right of P2-BWE. During onsite investigation, it was identified that the left main landing gear assembly had detached around the time the pilot noticed the left-wing drop.

The pilot stated during interview that when the aircraft came to a stop, he immediately shut down the engine and evacuated the passengers with the assistance of one of the Operator’s personnel who was also a passenger on board.

⁶ Bulk downward movement of air such as commonly found on the lee side of a mountain or caused by descending body of cool air. Source: The Cambridge Aerospace Dictionary.

⁷ A PAC 750XL aircraft, registered as P2-BWE. Refer to Section 1.18.6 for more information on this aircraft.

1.2 Injuries to persons

Injuries	Flight crew	Passengers	Total in Aircraft	Others
Fatal	-	-	-	-
Serious	-	-	-	-
Minor	-	-	-	Not applicable
Nil Injuries	1	6	7	Not applicable
TOTAL	1	6	7	-

Table 1: Injuries to persons

1.3 Damage to aircraft

The aircraft sustained substantial damage. Refer to *Section 1.12* for a detailed description of damage to relevant components of the aircraft.

1.4 Other damage

The outer edge of the right flap of P2-BWE, sustained an impact dent from P2-BWC's left wingtip. For further information, refer *Section 1.12*.



Figure 3. Damage caused to P2-BWE by P2-BWC.

1.5 Personnel information

1.5.1 Pilot

Age	: 63
Gender	: Male
Nationality	: Papua New Guinean
Position	: Check and Training Captain
Type of license	: CPL (A) ⁸
Type rating	: PAC-750, C404, E110
Total flying time	: 14,129.9 hours
Total hours in command	: 8,371.3 hours
Total hours on type	: 3,625.3 hours
Total hours last 90 days on type	: 53.9 hours
Total hours last 7 days on type	: 1.2 hours
Total hours last 24 hours on type	: 0.7 hours
Medical class	: One (1)
Valid to	: 04 May 2022
Medical limitation	: Nil

The pilot's flight records obtained from the Operator were reviewed and it was noted that the pilot had not been checked into Tekin. The records showed that since the pilot's employment with NASL, he had conducted a single crew operation into Tekin twice, before the accident flight.

1.6 Aircraft Information

According to the aircraft manufacturer, the PAC 750XL aircraft is a turboprop driven, all metal, low wing monoplane with a fixed tricycle undercarriage. It has been developed from a proven design to meet present and future needs for an economical aircraft with high load carrying capacity. Its robust construction, wide section, and low-pressure tyres enable operations from unpaved strips to be flown as a matter of routine.

The power plant, a Pratt & Whitney PT6A-34 turbine engine is enclosed in a 2-piece composites cowl, and drives a three or four blade, constant speed feathering and reversible pitch Hartzell propeller.

1.6.1 Aircraft data

Aircraft Manufacturer	: Pacific Aerospace Corporation Limited
Model	: PAC 750XL
Serial Number	: 136
Year of Manufacture	: 2007
Total Airframe Hours	: 6,752.6
Total Airframe Cycles	: 13,861
Registration	: P2-BWC
Name of the Owner	: Niugini Aviation Services Limited
Name of the Operator	: Niugini Aviation Services Limited

⁸ Commercial Pilot License (Aeroplane)

Certificate of Registration number : 047
Certificate of Registration issued : 18 December 2018
Certificate of Registration valid to : Non-Terminating
Certificate of Airworthiness number : 047
Certificate of Airworthiness issued : 18 December 2018
Certificate of Airworthiness valid to : Non-Terminating

1.6.1.1 Engine data

Engine Type : Turbo propeller
Manufacturer : Pratt and Whitney Canada
Model : PT6A-34
Serial Number : PCE-RBO433
Year of Manufacture : 2009
Total Time Since New : 5,766.7 hours
Cycles Since New : 9,880
Time Since Overhaul : 1,251.8 hours
Cycles Since Overhaul : 900

1.6.1.2 Propeller data

Propeller Type : Variable Pitch Propeller
Manufacturer : Hartzell Propeller Inc
Model : HC-B3TN-3D
Serial Number : BUA30860
Total Time Since New : 4,972.9 hours
Time Since Overhaul : 1,251.8 hours

1.6.1.3 Fuel information

All relevant documents containing fuel information were provided to the AIC by the Operator.

P2-BWC's fuel record showed that it had been refueled with 250 litres (L) of Jet A1 fuel on top of the remaining 300L, in Kiunga, prior to its departure. A total of 550L were on board on departure.

The propeller damage indicated that the engine was operating at the time of the accident. During the interview with the AIC, the pilot also corroborated this evidence by stating that the engine was operating normally during the flight.

The AIC determined that fuel was not a contributing factor to this accident.

1.6.2 Weight and Balance

The weight and center of gravity of the aircraft for the flight was considered during the investigation. *Section 1* of the *Pilot Operating Handbook and Civil Aviation Authority of New Zealand Approved Flight Manual Air 2825* for the PAC 750XL stated that the maximum certified landing weight for the aircraft is 3,232 kilograms (kg) and the maximum certified take-off weight is 3,402 kg.

The *Daily Flight Record (DFR)* for the accident flight showed that the aircraft departed from Kiunga with a take-off weight of 3,379 Kg and landed at Tekin Airstrip with a weight of 3,179 Kg.

The aircraft was within the weight limits for take-off and landing.

The Operator did not provide the *Load and Trim* sheet for the occurrence flight, therefore the investigation could not determine the weight distribution of the aircraft.

1.6.3 Minimum Equipment List

There was no outstanding Minimum Equipment List (MEL) item at the time of the accident.

1.6.4 Main Landing Gear System

The MLG system comprises of left and right gear assemblies using conventional type shock struts or oleo strut.

This is attached to heavy duty castings or machined fittings forming part of the center wing structure at the intermediate rib positions. The MLG assembly consists of the shock strut, the axle and the wheel and brake assembly. The MLG is attached to the aircraft structure by four 3/8 inch attachments bolts (Part Number (PN) MS21250-06078). Two brackets attach the MLG to the structure with the bolts at the lower side. The other hardware fasteners are; a washer being fitted on the bolt side and another washer being fitted with the nut for each of the attachment bolts fitment.

After the issue of the *Mandatory Service Bulletin (MBS) PACSB/XL/105 Issue 4* (refer to 5.1 Appendix A) on 19 December 2018, the attachment bolts were to be fitted with palnut on each of the bolts after the nuts to ensure the nuts are being secured, refer to figure 4.

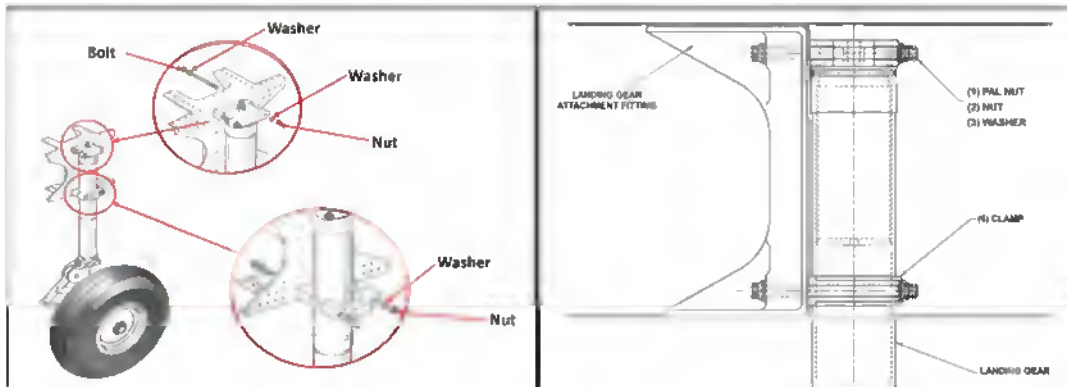

Figure 4. MLG and hardware fittings.

1.6.4.1 Main Landing gear Oleo Strut and its servicing

Shock struts or oleo struts are shock absorbers that cushion forces associated with aircraft landings and ground manoeuvres such as taxiing. Oleo struts are critical elements of aircraft landing gear, connecting an aircraft's wheels to the airframe to provide the main path through which load forces are transmitted from the ground to the airframe.

Shock strut is assembled with a piston and a bearing, and it is divided into two chambers by an orifice plate that allows the hydraulic fluid to travel between the lower and upper chambers. The lower part of the strut is filled with hydraulic fluid and the remaining space in the upper part of the strut is filled with nitrogen. The movement of this fluid through the orifice by the piston movement during landing and taking off reduces force and vibrations to the aircraft.

The bearing maintains alignment and smooth motion between the piston and cylinder during these operational activities.

Steel sockets at the lower end of the pistons provide attachment for the axle on which the tyre is fitted to and brake anchor plates. The lower arms of the torque links are bolted by brackets to the sockets whilst the upper arms are attached to alloy lugs at the base of the cylinders.

The MLG oleo strut is serviced in accordance with PAC 750XL Maintenance Manual (MM) (Refer to *section 5.2 Appendix B*).

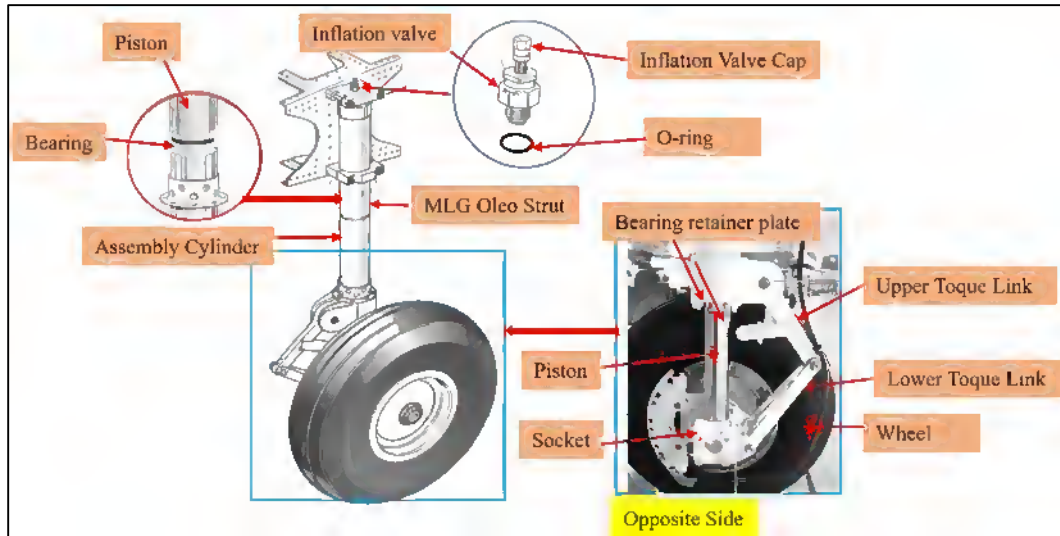

Figure 5. MLG Oleo Strut.

1.6.4.2 Aircraft Maintenance

1.6.4.2.1 Maintenance

The maintenance records were reviewed by the AIC and found that the last major scheduled maintenance on the aircraft was a Check 2 (300 hourly), carried out by the Operator from 14 to 22 January 2022 (Refer to *5.3 Appendix C*).

1.6.4.2.2 MLG attachment Bolts Replacements

According to the maintenance records, on 03 October 2019, the left MLG attachment bolts were replaced on a schedule maintenance in accordance with the former owner, Central Aviation's Customs Policy, refer to *Section 1.18.4.1* for more information on the Custom Policy.

There was no record of the bolts been replaced prior to the time of the accident.

The AIC also looked at the hours and the landings of the aircraft since the replacement of the attachment bolts were last carried out by Central Aviation in 2019 and identified that at the time of the accident, the MLG attachment bolts had accumulated 1,251.8 hours.

1.6.4.2.3 Mandatory Service Bulletin PACSB/XL/105 Issue 4

On 19 December 2018, the Pacific Aerospace Limited (PAL) issued a *Mandatory Service Bulletin (MSB) PACSB/XL/105 Issue 4* to the owners and operators of PAC 750XL aircraft with serial number (S/N) that were up to S/N 185 (excluding S/N 177). The *MSB PACSB/XL/105 Issue 4* specified, among other requirements to inspect the MLG attachment bolts and install palnuts as required.

The accident aircraft P2-BWC has S/N 136 and was subject to the *MSB PACSB/XL/105 Issue 4*.

According to the maintenance records provided by NASL, the *MSB PACSB/XL/105 Issue 4* was carried out by the Fleet Care Ltd⁹ on 03 October 2019.

1.6.5 Collision Avoidance Systems

The aircraft was equipped with a Mode C transponder and its serviceability was not a factor in this occurrence.

1.7 Meteorological information

1.7.1 PNG National Weather Service Forecast Data

The Area Forecast issued by PNG National Weather Service on 26 February 2022 was valid from 2300 UTC to 1100 UTC. The information is as follows:

Wind	: 2,000 ft, 20 kts : 14,000 ft, 25 kts : 7,000 ft 100° 10 kts
Cloud	: Isolated Cumulonimbus 18,000 ft : Broken Stratus clouds at 500 ft to 3,000 ft including precipitation : Scattered Cumulus 1,500 ft to 10,000 ft and broken rain and drizzle : Scattered altocumulus altostratus 10,000 ft to 18,000ft
Visibility	: 500 m in fog 3,000 m in thunderstorms and rain 4,000 m in showers of rain and rain drizzle
Weather	: Fog, Thunderstorms, Showers of Rain and Rain Drizzle
Turbulence	: Severe vicinity in Cirrus and Cumulonimbus

1.7.2 Tekin Local Weather

According to the Operator, local weather is assessed and reported over the phone by a company agent on the ground in Tekin. The pilot stated during the interview that the agent reported fog in the morning and later that day, reported that the sky was clear.

The pilot recalled his observation of the weather in Tekin area as good with few clouds and with minimum to no wind around the airstrip. He also stated that, from previous flights, he would usually encounter downdrafts during the final approach.

He added that there are usually downdrafts over the road situated before the airstrip when coming into land. He added that they expect to encounter strong winds at the airstrip starting around 9:30 (local) to evening.

⁹ An Aircraft Maintenance Organization based in New Zealand.



Figure 6. Reported downdraft area.

The investigation determined that the downdraft experienced by the pilot was about 60m from the designated landing threshold.

1.8 Aids to navigation

Navigational aids and their serviceability were not a factor in this accident.

1.9 Communication

The aircraft was equipped with a High Frequency (HF) and Very High Frequency (VHF) two-way communication radio. Both communication systems were determined to have been serviceable and not contributing factor to the accident.

1.10 Aerodrome information

Tekin Airstrip is located in Sandaun Province at an elevation of 5,632 ft, about 56 NM Northeast of Kiunga Airport. According to the PNG Airstrip Guide Year 2021¹⁰ edition used by NASL as a route and aerodrome guide, Tekin Airstrip is a one-way airstrip with a strip 18 up, and a strip 36 down.

Latitude	0514.69
Longitude	14209.874
Runway	18/36
Elevation	5,500
Landing Distance Available	494
Slope	10.5 N ¹¹
Remarks	L 18 T/O 36 Caution turbulence n SE wind

Table 2. PNG Airstrip Guide

As per the topography data, Tekin Airstrip is located in a valley surrounded with mountain ranges and is situated at the foot of a mountain that is about 8,720 ft (2,658m) high and has a long ridge extending in an East-West direction and is located to the south of the airstrip. There is a river also located in the valley, to the North of the airstrip, and runs in an East-West direction as well.

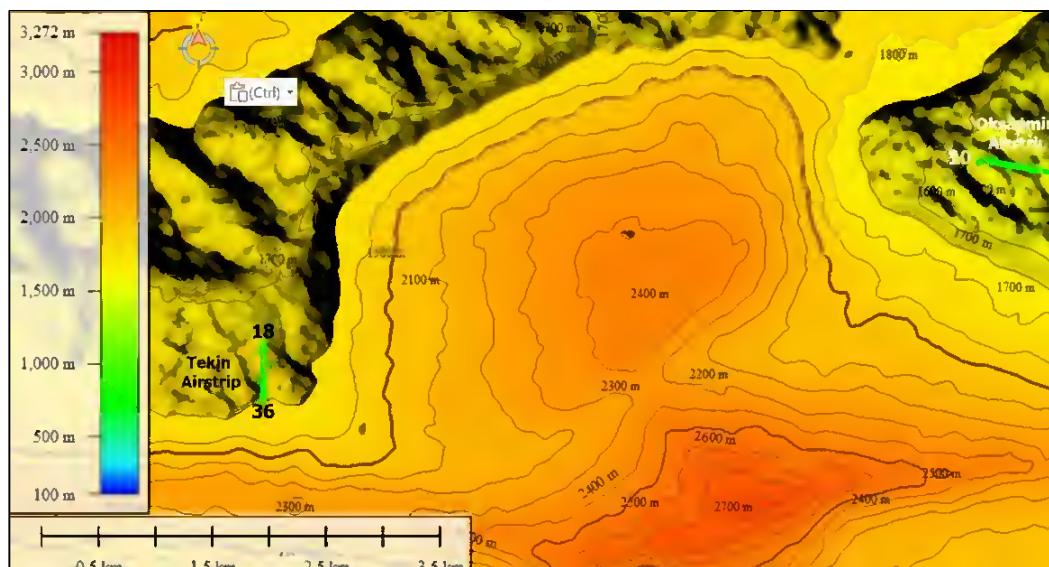

Figure 7. Tekin area Topography

The geographical position of the airstrip and its surrounding gives the area its own local wind and weather patterns.

¹⁰ A guide developed and published by RAA as a guide to pilots in matters helpful to operations, such as GPS settings, wind characteristics, and surface conditions and it is not a PNG CASA approved guide. This guide also states that the PNG Aeronautical Information Publication-Aerodrome (AIP) and Ground Aids (AGA) is a legal document governing aviation operation. Pilots are advised to always check NOTAMS for latest information.

¹¹ 10.5 Upslope



Figure 8. Localise Wind Pattern at Tekin Airstrip

1.10.1 On-site observation of Tekin Airstrip

During the onsite investigation, it was observed that the runway surface was hard and comprised of unsealed gravel with light overgrowth of grass. There were several water drainage run-offs from the centre of the runway towards the grass strip.

There were two windsocks at the airstrip. One windsock was located before the start of runway 18 and the second windsock was located towards the end of runway 18, on the left-hand side.

There is an inclination that begins from the grass strip just before the start of runway 18 that reaches an elevation of about 15cm.

There were two cone markers to the right of runway 18 about 2m up strip from the start. Their purpose was to indicate the threshold of the runway where the surface is levelled, however it was observed that the cone markers were not in a good condition to be clearly visible. The runway surface shows evidence of a normal touchdown point about 20-30m up strip of the threshold.

The investigation also found that at the time of the accident, the number of cones markers and positions were not in accordance with *CASA PNG AC 139-6, refer to 5.4 Appendix D*.



Figure 9. Observation at Tekin Airstrip.

1.11 Flight recorders

The aircraft was not equipped with a flight data recorder or a cockpit voice recorder, neither were they required by PNG Civil Aviation Rules.

1.12 Wreckage and impact information

1.12.1 Overview of the wreckage distribution

During the on-site investigation, it was established that the aircraft's left main landing wheel's initial touchdown was 5m short of the target threshold indicated by cone markers while the right landing wheel's initial touchdown point was 3m short of the target threshold. The touch down ground marks indicated that the MLG impacted the ground with a significant force.

As indicated in the pilot interview, the left MLG failed immediately subsequent to touchdown, and the aircraft's left wing dropped. The aircraft then rolled for 85m as it veered left of the strip and travelled for about another 79m upstrip before the left-wing tip struck the right wing extended flap of P2-BWE, which then caused P2-BWC to abruptly veer further left and skid across the runway strip boundary as the nose-wheel and right MLG bogged into the ground. The aircraft came to rest about 13m to the right of the P2-BWE wreckage.

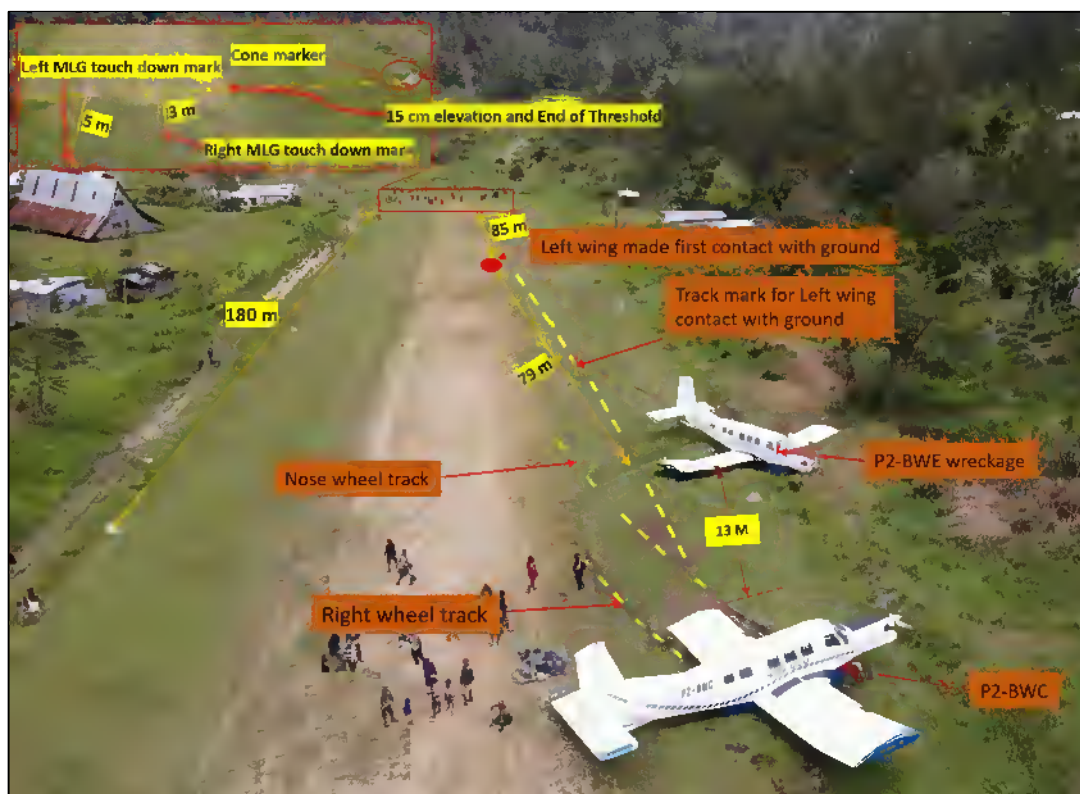

Figure 10. Landing mark on the strip.

1.12.2 Damage and wreckage Inspection

During the onsite investigations, it was noticed that the aircraft sustained substantial damage to its structure and certain components.

The left-wing inboard and the left horizontal stabiliser were punctured through from the bottom to the surface. The left wing tip also sustained damage and the flaps were found to be fully extended.



Figure 11. Damage to the aircraft structure.

The left MLG assembly indicated that the valve cap for the inflation valve of the MLG oleo strut was missing and the valve was found to be bent. There was evidence of hydraulic leakage on the valve and the piston was found to be fully compressed, no fluid present, in the cylinder assembly.

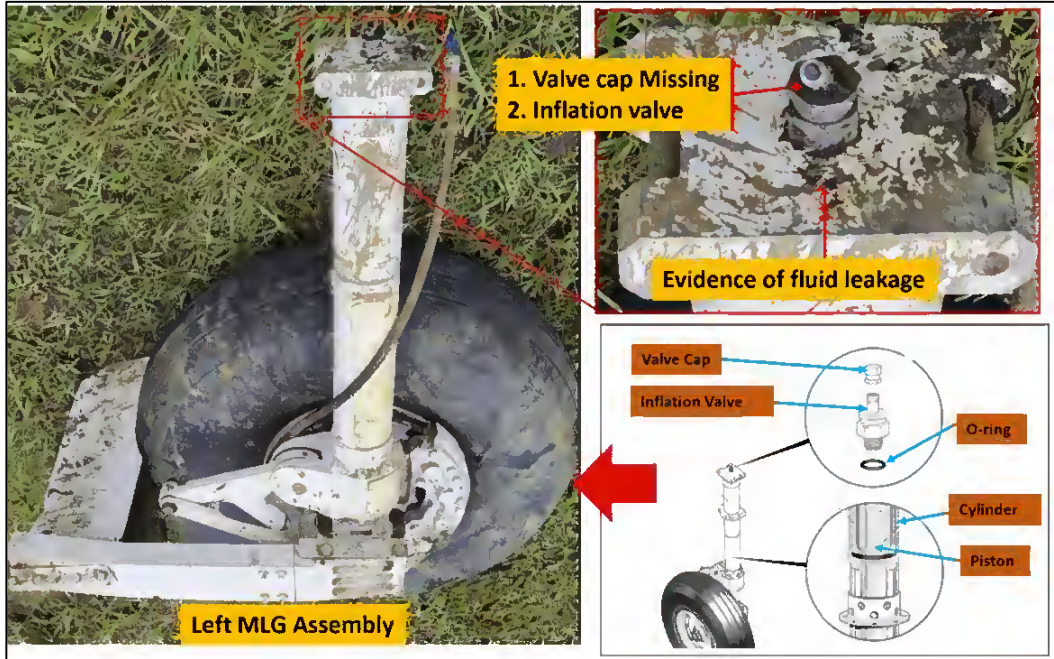

Figure 12. Damaged sustained on the left MLG.

The forward bolt for the lower attachment clamp was found to be intact with minimal bending to both the clamp and the bolt. However, the aft side of the clamp was snapped off with the aft bolt. The investigation also noted that the two top attachment bolts were completely snapped off.

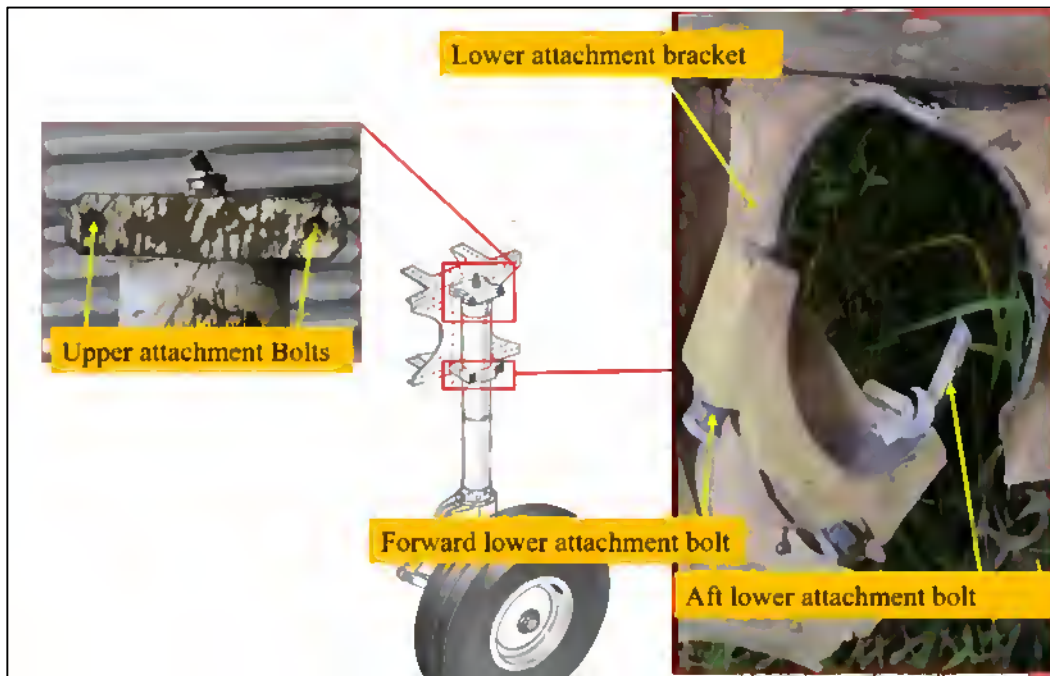

Figure 13. Damage sustained on the attachment brackets and bolts

1.13 Medical and pathological information

No medical or pathological investigations were conducted as a result of this occurrence, nor were they required.

1.14 Fire

There was no evidence of pre- or post-impact fire.

1.15 Survival aspects

1.15.1 Search and Rescue

The pilot called ATS at 9:40 when he had arrived in the circuit area and advised them that he would call on the ground after landing. However, the pilot did not call back.

At 09:52, ATS began calling P2-BWC as they had not received a SARWATCH¹² cancellation call on the ground. Subsequently ATS tried calling P2-BWC on two different radio frequencies, 8.861 MHz and 5.565 MHz, several times but were unable to establish radio communication with the aircraft. The ATS then declared an INCERFA¹³ at 09:54 and subsequently called a helicopter, P2-HSH which was in the circuit area at Kiunga Airport at that time and requested if the pilot could call the unreported aircraft. There were several calls made by the ATS on the same HF radio frequencies, however, they were unsuccessful in establishing radio communication with P2-BWC.

At 10:01, P2-HSH made a radio call to reach P2-BWC but did not receive any response.

¹² Pilots to cancel when deemed safe arrival at the destination.

¹³ Uncertainty phase

According to the evidence provided, the Operator contacted ATC at 10:05 informing them about the accident and that all seven persons on board were safe and aircraft had structural damage. ATS subsequently cancelled INCERFA.

1.15.2 Emergency Locator Transmitter

The aircraft was fitted with an ACR ARTEX ME406 Emergency Locator Transmitter (ELT), part number 453-6603 and Serial Number 03005 in accordance with *CAR 91.529*.

The ATS informed PNG AIC that there was no COSPAS SARSAT distress message received from P2-BWC's ELT. During the investigation, it was observed on the ELT that the expiration date was April 2021. The investigation identified that the ELT battery had not been replaced after the expiration date in accordance with *PNG CAR Part 91.605(e)(4)(iii)* which states,

(e) Except as provide in paragraph (f) and rule 91.611, the operator of an aircraft must not operate the aircraft unless-

(4) every emergency locator transmitter that is required to be installed in the aircraft under subpart F-

(iii) has had its batteries replaced or recharged when their useful life or, for rechargeable batteries, their useful life of charge, as established by the manufacturer, has expired; and

1.16. Tests and Research

1.16.1.1 MLG Disassembly and Inspections at PNG AIC Lab

The left MLG assembly was transported to AIC Lab facility and an examination was conducted on it. There was damage sustained to the oleo valve and stone deflector. The brake assembly was intact. The other associated external components were found to be intact and there was no

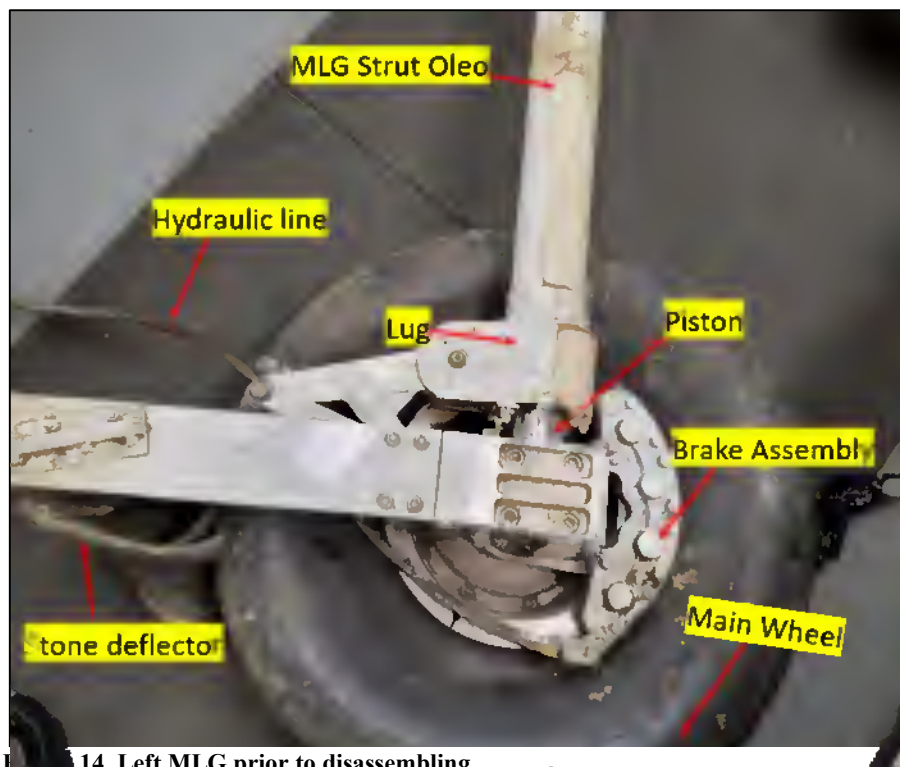

Fig 14. Left MLG prior to disassembling.

evidence of hydraulic leakage on the piston apart from surrounding the inflation valve nor damage to the integrity of the MLG strut oleo and the piston

During the inspection, the investigation found two washers on each of the upper clamp bolts and noted that there was no pal nut installed on each bolt. The Flight Care New Zealand informed PNG AIC that washers were fitted to ensure the bolts have thread available for the nut to be fitted well.

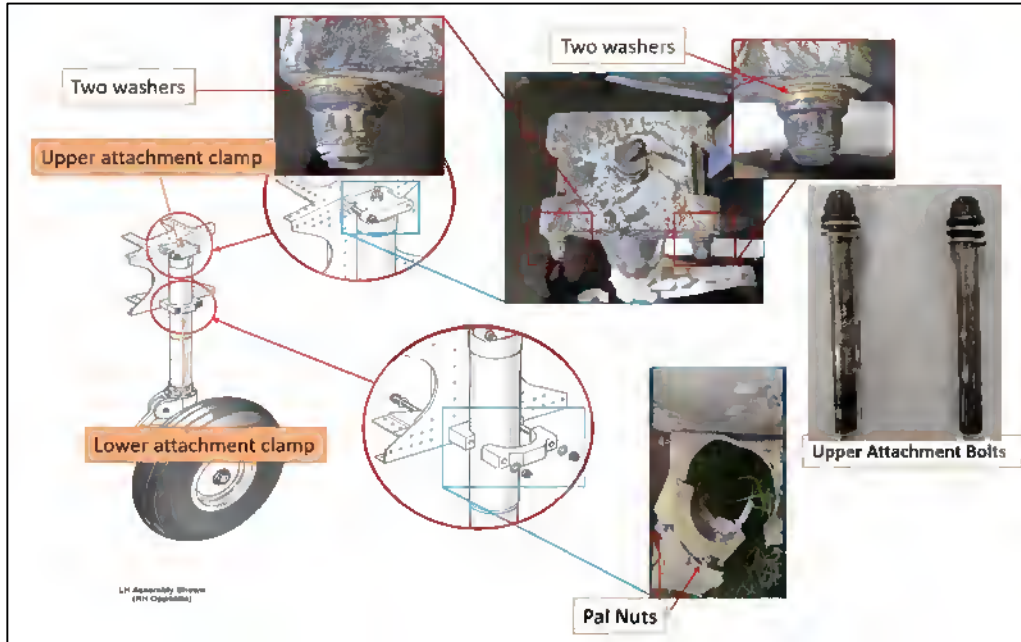

Figure 15. Left MLG attachment fasteners.

1.16.2 Disassembling left MLG

The AIC disassembled the left MLG at their Laboratory facility to find out further information about its associated component that may have caused the fluid to leak.

The piston was removed from the cylinder without any force. It was noted that there was no damage to the piston nor abnormalities observed. There was evidence of hydraulic fluid on it.



Figure 16. Observations on the MLG oleo strut.

The inflation valve for the oleo strut was removed and found that there was O-ring fitted. The MLG lug was also removed from flange and noted that there was no damage, nor any abnormalities observed on these components. Following the removal of the bearing from the cylinder, it was indicated that both internal and external seal (O-ring) were well fitted and intact in the groove.

The O-rings and seal were removed from the groove and further examined. There was no damage observed.

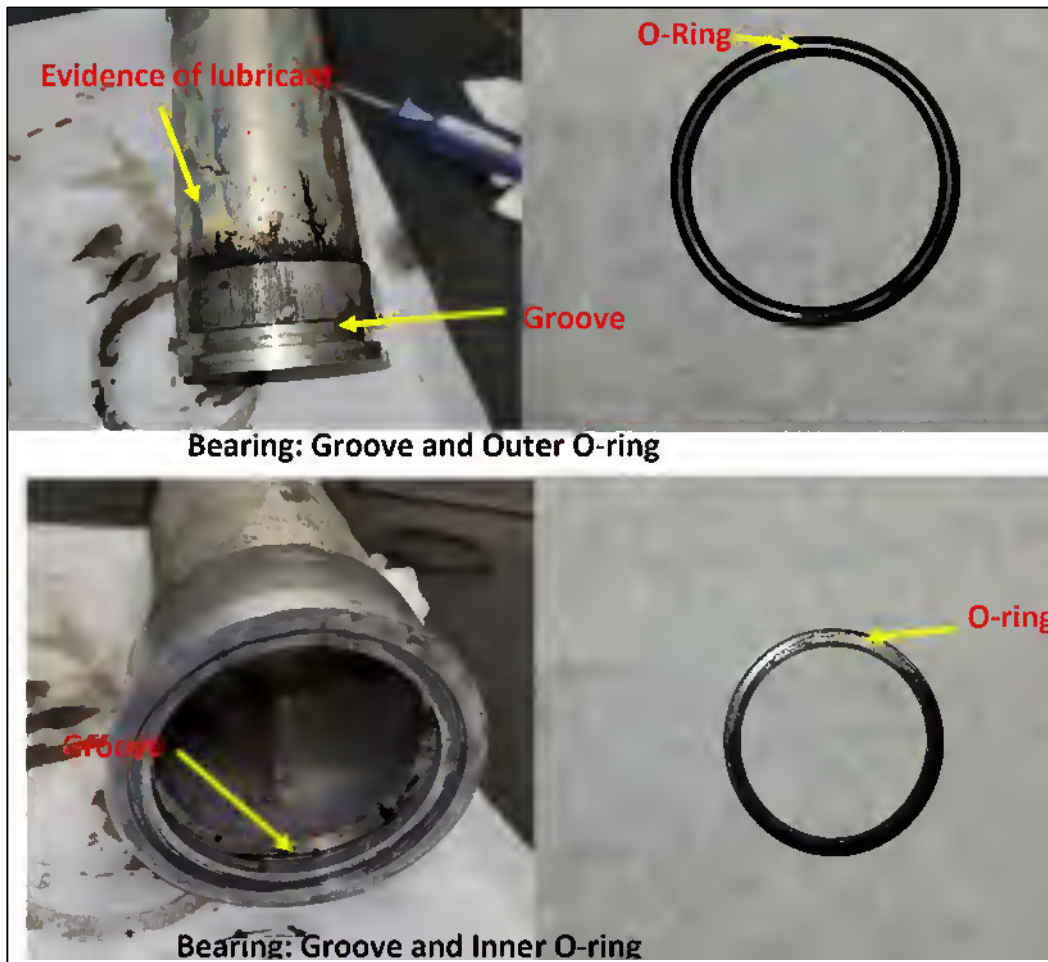

Figure 17. Observations on the Bearing and O-rings.

1.17 Organisational and Management Information

1.17.1 Niugini Aviation Services Limited (NASL)

NASL is an aircraft Operator which conducts charter and regular Fares & Freight (F&F) operations under the VFR category, within PNG. Most of its operations are into remote areas servicing rural communities.

NASL holds an Air Operator's Certificate, or AOC number 119/063 issued under CAR 119 for fixed wing air operations in accordance with CAR Part 135 on 15 December 2021 and expires on 30 December 2023.

The Operator also holds a Maintenance Organisation Certificate, or MOC number: 145/063 current issue on 1 November 2021, and expires on 31 October 2023. The NASL Maintenance Organisation is based at Mt. Hagen (Kagamuga) Airport, Western Highlands Province.

1.17.1.1 Quality and Safety management

NASL has an integrated Safety and Quality Management System (SQMS) which is a formal organisational system to manage safety and quality. It defines the safety and quality management process that encompasses all the functions of the organisation clearly showing how the safety and quality management activities integrate with all operational activities and how the organisation's desired outcomes are attained. It comprises the structure, responsibilities, processes, and

procedures of an organisation that taken together, promote and establish an environment and culture of continuing improvement and thus enhance the safety of aircraft operations.

The Safety Management Systems manage safety through a continuing process of hazard identification and risk management. The Quality Management System systemically assesses the level of compliance and continuous improvement process with *PNG CAR Part 100* and any applicable CASA regulations. The Quality Management System and Safety Management System responsibilities are assumed by the same senior person.

The Hazard Management Process which included hazard identification and reporting for assessment and correction was captured in the Operator's *Safety and Quality Manual*, section 7.2 pursuant to *PNG CAR Part 100.59 'Hazard identification'*

During the investigation, the Operator provided AIC with the Hazard and Occurrence Register on 23 May 2022. A review identified that the 2021 Register only contained hazards and risk assessments records for reported occurrences for other airstrips, excluding Tekin. There were no other records of hazards.

1.17.1.2 Calibration of Tools and Equipment

The Operator's approved *Maintenance Organisation Manual Section 4* requires the Operator to carry out the Calibration of Tools and Equipment pursuant to *CAR Part 145.107 Equipment, tools, and material*.

The Engineering Manager is responsible for ensuring the equipment and tools that need calibration are removed from service, tagged as unserviceable and quarantined prior to their expiration date. Refer to 5.5 Appendix E.

AIC requested NASL to provide evidence of calibrated tools and equipment such as strut oleo servicing nitrogen gauge and Tyre Inflator-TDR for performing aircraft maintenance.

According to the manufacturers,

- the details of the Nitrogen regulator is found to be, Maximum Outlet pressure 3,000(kPa), flow rate of 1,600 (l/min) and the pressure gauge range as 30,000 kPa for inlet and 4,000 kPa for outlet gauge
- the Tyre Inflator-TDR 2000 has a maximum supply of 200 psi and maximum inflation of 138 psi. It has an accuracy tolerance of 2 plus or minus for the reading ranges between 25 psi to 75psi

The Operator provided evidence of an existing Nitrogen regulator with two fitted gauges connected to the Nitrogen bottle and a Tyre Inflation gauge, however, the evidence did not show the calibration date and expiration date.

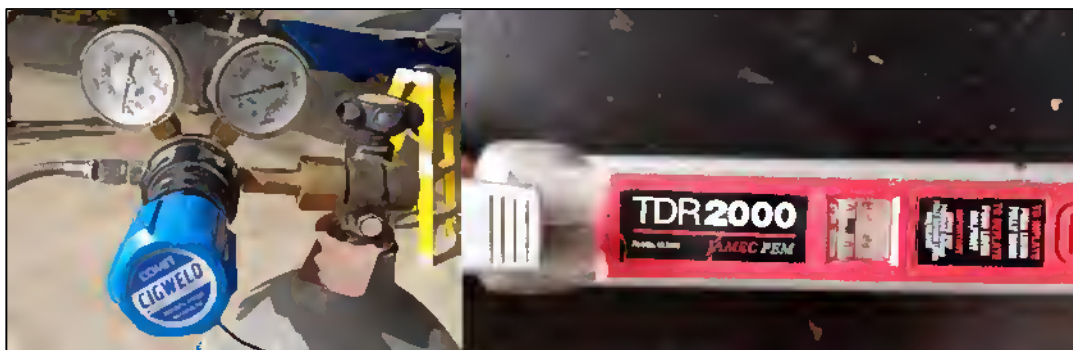

Figure 18. Left, Nitrogen Regulator and Right, Tyre Inflator.

Therefore, AIC requested the Operator to provide records of calibrated tools. The Operator provided a tool and equipment calibration register which did not include records of the Nitrogen regulator gauges and tyre inflation gauge. Upon further query regarding the calibration records of the two gauges, the Operator stated that they were sent to PNG National Institute of Standards and Industrial Technology (PNG NISIT) for calibration. After the calibration, the Operator provided the gauges, without their calibration records.

The investigation then requested NISIT for tool calibration records of the concerned gauges. PNG NISIT provided the records for 2019 to 2021. In these records, the two concerned gauges were not included.

1.17.1.3 Training and Competency

1.17.1.3.1 Route and Aerodrome training

The Operator's *Training and Competency Manual*, section 6.1 (A)(1)(2) requires each pilot acting as pilot-in-command to within the immediately preceding 12 months, pass a check of route and aerodrome proficiency that is administered by a flight examiner and that.

- (i) consists of at least one flight over one route segment and one or more landings at aerodromes representative of the operations to be flown; and*
- (ii) establishes that the pilot can satisfactorily perform the duties and responsibilities of a pilot-in-command in air operations appropriate to this Part.*

This Section is in compliance to PNG CAR Part 135.607(a)(1)(i), *Flight Crew Competency Checks* which states;

- a) A holder of an air operator certificate must ensure that —*
 - (1) for each pilot acting as pilot-in-command has, within the immediately preceding 12 months, passed a check of route and aerodrome proficiency that is administered by a flight examiner and that*
 - (i) consists of at least one flight over one route segment and one or more landings at aerodromes representative of the operations to be flown; and*

According to the *Training and Competency Manual*, section 5.3.3 'Training at Special Characteristics Aerodromes, a Special Characteristics Aerodrome is identified with the following features;

- 1. One-way landing strip*
- 2. One-way take-off strip*
- 3. Longitudinal surface gradient of more than 1:50 (2.0 %)*
- 4. Uneven longitudinal surface gradient*
- 5. Is subject to wind conditions conducive to the formation of subsidence or wind shear*
- 6. Is subject to excessive cross wind conditions for the aeroplane type in use*
- 7. Is subject to excessive tail wind conditions for the aeroplane type in use.*
- 8. Special knowledge required to execute a baulked approach*

For the Special Characteristics Aerodrome, a pilot is required to demonstrate to a Check Captain or Line Training Captain the ability to land and take off an aeroplane with an operating weight equivalent to the maximum permissible weight for an aerodrome.

The investigation identified that Tekin Airstrip falls under a Special Characteristic Aerodrome.

There is variation to the route and aerodrome qualification training as stated in section 5.3.5 (3) of the Operator's *Training and Competency Manual*.

At the discretion of the Flight Operations Manager, the training for route and aerodrome qualification may be reduced when;

1. the pilot requiring qualification has in excess of 500 Hours experience of flying in Papua New Guinea;
2. the aerodrome concerned is not one that would come under the description of having special characteristics;
3. the aerodrome is listed in the Route Intelligence Manual and the pilot has studied the details relevant to it and in AIP AGA.

Therefore, the pilot had to be checked into the Aerodrome before operating into Tekin Airstrip, however, during the interview, the Operator informed the investigation that the Flight Operations Manager used his discretion to allow the pilot to not to undergo the aerodrome check into Tekin Airstrip. The Operator also informed the investigation that the FOM's decision was based on the pilots previous flying experience.

1.17.1.4 Route and Aerodrome Guide

According to PNG CAR 135.77 Use of aerodromes;

The certificate holder shall, where its aeroplanes use an aerodrome not promulgated in the PNGAIP, maintain a register containing—

- (1) the aerodrome data; and
- (2) procedures for ensuring that the condition of the aerodrome is safe for that operation; and
- (3) procedures for ensuring that the condition of any required equipment, including safety equipment, is safe for that operation; and
- (4) any limitations on the use of the aerodrome

During the investigation, the Operator informed AIC that they were using PNG Airstrip Guide, Year 2021 edition as a route and aerodrome guide with Tekin airstrip data as follows,

Latitude	0514.69
Longitude	14209.874
GP	4
Runway	18/36
Elevation	5,500
LDA	494
Slope	10.5 N
Remarks	L 18 T/O 36 Caution turbulence in SE wind

Table 3. PNG Airstrip guide used by Operator for Tekin Airstrip.

A review of the Airstrip Guide by AIC identified that the Guide did not contain information as required under CAR Part 135.77(C)(2), (3) and (4) requirements.

1.17.2 Civil Aviation Safety Authority of PNG (CASA PNG)

CASA PNG is a statutory body with a legal mandate to promote aviation safety and security through effective safety regulation of the civil aviation industry, with particular emphasis on preventing aviation accidents and incidents within the civil aviation system in Papua New Guinea.

1.17.2.1 Pilot Records

The *Civil Aviation Act 2000 (As Amended) Section 66*, states:

- (1) *CASA shall establish a Civil Aviation Registry,*
- (2) *Copies or appropriate evidence of the following shall be recorded and maintained at the Registry,*
- (b) *every current aviation document.*

The *Civil Aviation Act 2000 (As Amended)* defines aviation document as:

A licence, permit, certificate, or other document issued under this Act to or in respect of any person, aircraft, aerodrome, aeronautical procedure, aeronautical product or aviation related service.

During the investigation, the AIC requested for current pilot's record from CASA PNG. They were unable to produce the requested information because they were unable to locate the pilot's file in their registry.

1.18 Additional information

1.18.1 NASL Change Management Process

According to *PNG CAR Part 100.65 (a)(b)*,

- (a) *An applicant for the grant of an organisational certificate must establish and maintain documented procedures for managing changes to the certificate holder's organisation and operation.*
- (b) *The procedures required by paragraph (a) must—*
 - (1) *define the operation in sufficient detail to provide a baseline for evaluating change; and*
 - (2) *include processes for identifying changes to the organisation and to the operation; and*
 - (3) *procedures for applying risk analysis and risk mitigation to changes; and*
 - (4) *describe the safety management arrangements for implementing changes and on-going safety monitoring; and*
 - (5) *identify the means by which all person affected by a change are notified during the development and implementation of the change.*

A thorough review of the specific contents about management of change contents in the Operator's *Safety and Quality Management System Manual* showed that the Operator had established procedures for managing changes to the organisation and operation in their *Safety and Quality Manual, Section 15*.

Acquisition of Central Aviation included introduction of two additional used aircrafts that were of the same make and model to their existing PAC750 XL aircraft, which meant introduction of new procedures. When changes happen, the system has to be amended to include changes to the organisation and the knowledge and expertise to keep the system running.

There was no evidence of change process carried out by Niugini Aviation Services Limited before the acquisition of Central Aviation.

1.18.2 Tekin Airstrip Survey Report

A survey of Tekin Airstrip was carried out on 21 May 2020 by Mission Aviation Fellowship (MAF) PNG Limited in accordance with *Advisory Circular 139-6 (CASA PNG AC 139-6)* (Refer to 5.4 Appendix D for CASA PNG AC 139 and 5.6 Appendix F for the Tekin Airstrip Survey and -6). The survey information was reviewed, approved, and provided to the investigation by the Rural Airstrip Agency (RAA), refer to Section 1.18.3 for more information. The airstrip information provided is as follows:

Elevation	5,632 ft (at threshold)
Coordinates	Latitude: 05°14'41.64"
	Longitude: 142°9'52.56"
Runway length	531 m (1,742 ft)
Runway width	24 m (79 ft)
Slope	9.6% North
Surface conditions	Short grass, fine-grain soil (silt, clay), rough with some undulations

Table 4. RAA survey data for Tekin Airstrip.

According to the survey that was carried out, in Section 3.2 *Take-off Climb/ Approach Surface* of AC139-6, the Take-off Climb/Approach surface at Tekin Airstrip did not have

–

- a) 5% rise from the horizontal; and
- b) 5% side splay (left and right); and
- c) Clear for 600m horizontally.

Five obstacles (trees) were found to be within 600m of the Take-Off Climb/Approach horizontal surface, and four were penetrating the obstruction limitation surface (OLS).

The survey determined that with the prevailing conditions regarding the airstrip's OLS, the threshold is required to be displaced further up-strip to ensure that the take-off climb/approach OLS is clear. However, as it is, the airstrip was deemed not compliant with *CASA PNG AC 139-6* and was determined to not be unsafe for aircraft use.

1.18.3 Rural Airstrip Agency (RAA)

RURAL AIRSTRIP AGENCY (RAA) OF PNG LIMITED (CN 1-87723) is a not-for-profit company. RAA, a wholly owned subsidiary of Mission Aviation Fellowship (MAF PNG Holding Limited) with a widely representative board including members from the National and Provincial Governments, airstrips owners, aircraft operators and donor organizations.

RAA has been established for the primary purpose of facilitating and conducting maintenance and restoration of rural airstrips in Papua New Guinea. These activities are aimed at improving aviation safety and providing greater access by remote communities to essential services such health, education, community development and commercial markets for cash crops. RAA has been created as an interim to the establishment of the Rural Airstrip Authority, a PNG Government statutory body.

The RAA maintenance program is based on a continuous maintenance model. This program is for airstrips that are currently usable and require the minimum amount of work, such as cutting grass, checking and repairing surfaces etc to keep them open. Recently restored airstrips are added to the program after restoration work is complete.

Training of airstrip maintenance officers (AMO) is part of the program. The AMOs are from the airstrip community. They are trained to cut grass using a industrialised lawn mower, provide daily reports on conditions of airstrip, cleaning drainages, placing of cone marker, reporting wind sock conditions and more. This enables airstrips to meet the maintenance standard (*CASA PNG AC 139-6*) and remain operational.

1.18.4 Maintenance Manual Supplements (MMS) 750XL

On 14 April 2016, PAL issued a *MMS 750XL MODIFICATION PAC/XL/0663 RETROFIT MLG ATTACHMENT BOLTS-7/16"* to replace the existing 3/8 inch bolts with a new 7/16 inch bolts refer to *5.7 Appendix G*. This MMS was applicable to all short-range wing aircraft that were manufactured before the extended range wing aircraft was developed and put into production in May 2012.

P2-BWC is a short-range wing aircraft and was manufactured before the extended range wing aircraft was developed and therefore it was fitted with the 3/8 inch attachment bolts and was affected by *MMS MOD PAC/XL/0663*.

PAL stated that, if there were any issues with bending or cracking of the bolts or oversized fitting holes, the operators should request for an upgrade of the 3/8 inch bolts to the 7/16 inch bolts. According to PAL's record, *MOD PAC/XL/0663* had not been carried out on P2-BWC. The aircraft logbook did not indicate that this modification had been carried out.

1.18.4.1 Customs Policy for MLG attachment bolts

According to PAL, the PAC 750XL Maintenance Manual does not define a schedule for replacing the MLG attachment bolts, but it is common practice for operators to replace these bolts based on their internal Company Policy in conjunction with normal scheduled maintenance. Operators normally refer to this Policy as a Custom Policy.

The Central Aviation developed a Custom Policy after they noticed that the attachment bolts were deteriorating at 1000 hours. With that, a policy was established to replace the MLG attachment bolts every 900 hours or every third Check 2 and was tracked on the system by Air Fleet Management, an organisation who was engaged for their Maintenance Control.

During the investigation, Air Fleet Management informed AIC that there is no procedure behind a particular task if it will be requested to be treated under customs policy since it is a single task setup in the Maintenance Control tracking system. Therefore, once tracking hours or landing of a particular task is established, the task is automatically set into the tracking software for monitoring and tracking purposes.

Air Fleet Management also informed the investigation that they had verbally passed the Custom Policy regarding the MLG attachment bolt replacement to the new Central Aviation Maintenance Controller at that time. Since Central Aviation is no longer in operation, the evidence to show that this information was passed from Air Fleet Management to Central Aviation could not be verified.

The AIC also requested NASL to provide any Custom Policy that they used for the MLG attachment bolt replacement or maintenance, however, NASL informed the investigation that they did not have a Custom Policy to cater for MLG attachment bolts replacement.

The investigation determined that the Custom Policy was not passed to NASL by either the Air Fleet Management or Central Aviation.

1.18.5 Visual Illusions

According to the Federal Aviation Administration (FAA) of the United States in its *Pilot's Handbook of Aeronautical Knowledge (PHAK)*, Chapter 17. *Aeromedical Factors*, pg. 17-11:

An upsloping runway, upsloping terrain, or both can create an illusion that the aircraft is at a higher altitude than it actually is. The pilot who does not recognize this illusion will fly a lower approach. Downsloping runways and downsloping approach terrain can have the opposite effect.

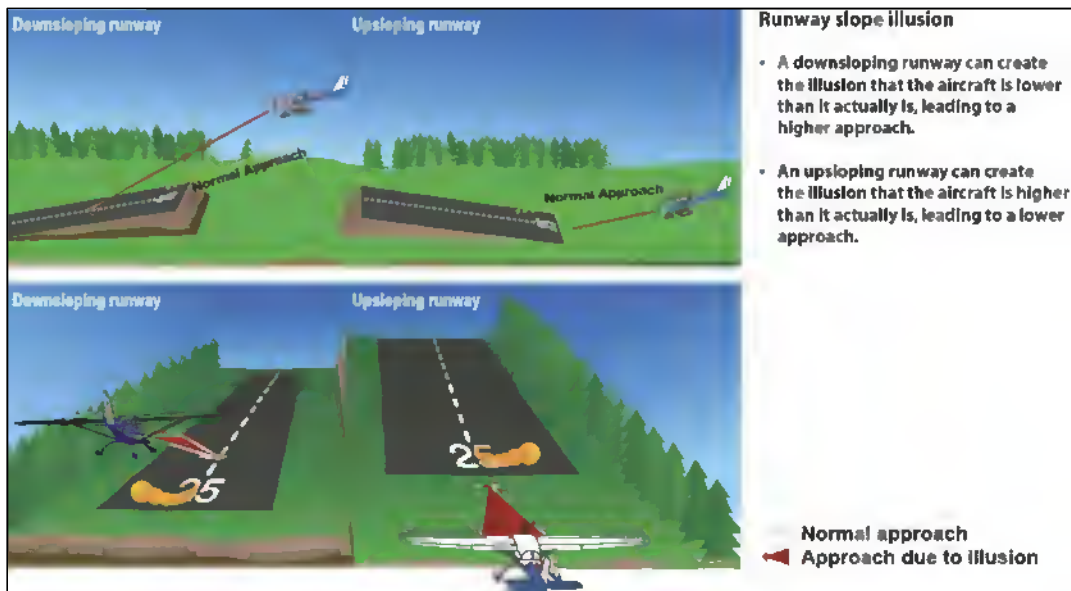

Figure 19. Upslope and downslope visual illusions. (Source: FAA PHAK, Figure 17-7)

1.18.6 A PAC 750XL Aircraft Accident in Tekin on 10 January 2022

A similar accident involving another NASL PAC 750XL aircraft, P2-BWE, occurred on 18 January 2022. The aircraft was still on the airstrip infringing the runway strip at the time the accident involving P2-BWC occurred on 26 January 2022.

This accident occurred eight days earlier at the same airstrip and sustained landing gear failure in a similar manner as P2-BWC, refer to AIC 22-1001 P2-BWE Accident Report on the PNG AIC website.

1.18.7 Occurrences involving rural airstrips from 2010 to 2022

During the investigation, AIC used the accident data from 2010 to 2022 and generated a graph showing the number of rural aircraft accidents in airstrip involving operators operating under *CAR Part 135* and *CAR Part 125*. Also, a google earth display was generated from the data to show the rural airstrips and their respective locations.



Figure 20. Rural Airstrip accidents per year.

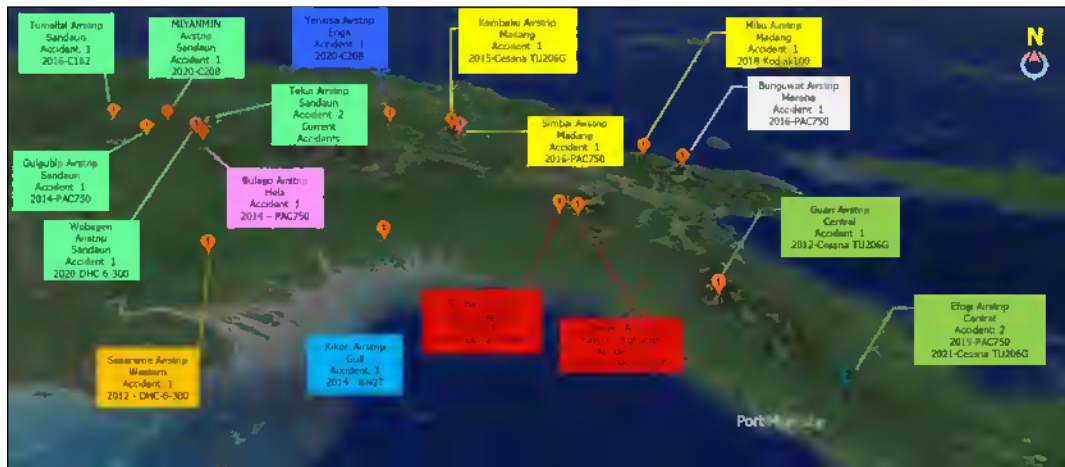

Figure 21. Accidents at rural airstrips and the geographical locations of the airstrips¹⁴.

The AIC found that with an average of about two accidents per year and this has been an aviation safety concern for the travelling public into rural airstrips.

1.19 Useful or effective investigation techniques

The investigation was conducted in accordance with the *Papua New Guinea Civil Aviation Act 2000 (As Amended)*, and the Accident Investigation Commission’s approved policies and procedures, and in accordance with the Standards and Recommended Practices of *ICAO Annex 13* to the *Chicago Convention on International Civil Aviation*.

¹⁴ Refer to 5.8 Appendix 8 for larger version.

2 ANALYSIS

2.1 General

The analysis of this report will discuss the relevant issues and circumstances resulting in P2-BWC aircraft experiencing a landing roll accident at Tekin Airstrip, Sandaun Province.

The analysis will therefore focus on the following issues.

- Flight Operations
- Tekin Airstrip Conditions
- Organisational
- Maintenance and Tooling
- Search and Rescue

2.1.1 Flight Operation

The pilot recalled maintaining an airspeed of 80 knots during the approach and reduced the airspeed to 75 knots during the flair and touchdown. The pilot stated that he encountered a downdraft during the approach, about 70 m from the designated landing threshold. The investigation believes that the pilot maintained this slightly higher speed to counter the effect of a potential downdraft on the aircraft.

The pilot stated that he retracted flaps after touch down. Although this is a normal step that is actioned during landing, the time and distance between the touchdown point and the main landing gear collapse point does not appear to be sufficient to allow a retraction of flap. The flap retraction could not have immediately occurred upon touchdown, within 2m of touchdown. The pilot confirmed that after the gear collapse, everything happened in an instant, and the pilot was trying to establish lateral control.

The investigation found no indication/evidence that would suggest that the flapless landing was intentional. The pilot believed that he had the flaps extended while configuring the aircraft for landing.

Approaches without the extension of flaps would also produce higher speeds for the same power setting as it would for a landing flap configured aircraft. For one way airstrips with limited runway length, it is crucial that the aircraft is properly configured for landing.

The investigation observed that the aircraft flaps were in the retracted position during on-site investigation. The investigation could not conclude for certain that the flaps were extended during approach or if they remained retracted throughout.

The left wing-tip clipped the extended right flap of P2-BWE, which was an obvious hazard on the airstrip from an accident seven days prior. The AIC is concerned about the decision to resume operations without a proper risk assessment for the airstrip following the accident to P2-BWE on 18 January 2022.

Reviewing the flight records of the pilot, and from interview, the AIC deduced that the pilot was not adequately familiarised with Tekin airstrip. The lack of familiarity including airstrip and area conditions, hazards and mitigation measures, operational techniques, etc, as the pilot had not been trained and checked into the airstrip.

Conducting a safe approach and landing requires the pilot to recognize and mitigate certain risks associated with operating into those special characteristic airstrips. As there are no approach aids on the ground at Tekin and most other special characteristic airstrips in PNG, pilots rely on their

experience and training into special characteristic airstrips for conducting safe flights into those airstrips. To verify that the aircraft is on the profile, pilots constantly monitor and adjust the approach profile relying on other visual cues and estimations. These are developed through training, experience, and familiarization.

The pilot stated that he was anticipating a downdraft as he had experienced it before. He added that during approach, he encountered a downdraft.

The visual illusion associated with Tekin airstrip is also likely to have given the pilot the perception that he was too high on approach. The investigation believes that the pilot landed short because he was low on profile due to the visual illusion and had a shallow approach profile as the flaps were in the retracted position.

The AIC noted that the Operator's Training and Competency Manual does not allow the Operator from exempting a pilot from Aerodrome Checks for special characteristic airstrips. However, the Operator's pilots were operating into those airstrips without aerodrome checks. The Operator stated that the pilot had significant experience in PNG rural airstrip operations and therefore the pilot was not checked into Tekin airstrip. The investigation believes that recruiting an experienced pilot does not take away the obligation of the Operator to verify that the pilot can conduct safe operations into airstrips. Furthermore, the Operator's manual did not give discretion to anyone to exempt a pilot from checks into special category airstrip.

2.1.2 Tekin Airstrip

The AIC identified that although the runway surface conditions at Tekin Airstrip was suitable for the aircraft to land at the time of the accident, there were some existing hazards such as the two cone markers that did not clearly indicate the threshold for the normal touch down point, 20-30m up strip. The AIC determined that this hazard could have contributed to the pilot landing the aircraft short of the threshold.

The investigation observed that the surrounding topography of Tekin airstrip significantly influences the flow of air. Downdrafts are common in these types of airstrips, i.e, airstrips located in valleys. The AIC concluded that downdrafts are a hazard common to Tekin airstrip.

There was an obvious obstacle on the edge of the airstrip. The AIC concluded that this limited the usable width of the airstrip and was a major collision hazard for the aircraft.

From the review of Tekin airstrip information from the Operator against that of the Rural Airstrips Agency, the investigation observed significant variations in data value and descriptions. The data from the Operator's strip guide appeared outdated. The observations of the AIC on-site team showed that the data from the RAA was more representative of the airstrip.

The investigation found that the Tekin airstrip survey data was not available to the Operator. As airstrip information generated or collected by qualified RAA experts, the data appeared to be a better source of airstrip information than the Operator's own data. The AIC believes it is of great benefit that Operators are provided the survey data and reports generated by the RAA. At the least, even as unofficial sources for awareness as the airstrip data that most Operators rely upon are outdated. The AIC has, through its investigation, found this to be true for almost all aircraft accidents at rural airstrips.

2.1.3 Organisational

2.1.3.1 Aerodrome Checks

The AIC found that although Operator's procedure for Route and Aerodrome Check was in accordance with *PNG CAR Part 135.607(a)(1)(i)*. There were no records to show that the pilot had undergone a route and aerodrome check since he had been employed by the Operator. It appeared to the AIC, from the training records, the flight data, and pilot interview record that the pilot was not adequately familiar with operations into the aerodrome and the hazards associated with the airstrip.

During interview, the Operator informed the AIC that the pilot had been exempted from aerodrome checks because he had significant experience operating into rural airstrips within PNG. The investigation found that the Operator's SOP did not give the Operator the discretion to exempt pilots from undergoing aerodrome checks into 'Special Characteristics' airstrip, including Tekin Airstrip. Tekin Airstrip met the conditions of a Special Characteristics airstrip as per the Operator's manual.

Conducting aerodrome Checks for Special Aerodrome Airstrip is important for the safe operation of aircraft into those airstrips. If the pilot had been checked into Tekin airstrip, it would have helped the pilot to become familiar with special conditions of operation, hazards, landing, and take-off techniques which would have helped the pilot to operate proficiently and more awareness of hazards such as runway upslope visual illusion, strip surface conditions, etc. The AIC is not stating that if the pilot was checked into the airstrip, the accident would have been prevented. The AIC can state though, that proper familiarization would have allowed the pilot to mitigated certain risks associated with operating into Tekin airstrip.

2.1.3.2 Hazard Identification and Risk Management

The investigation observed that the Operator had existing procedures for their Safety Management System which included Hazard Identification, Reporting, Risk Assessment and Management. However, there were no records to show that hazard identification and risk assessments had been conducted for the aerodromes and airstrips the Operator's aircraft was operating into, including Tekin airstrip.

Although the pilot, during interview had pointed out certain known hazards which were also identified by the onsite investigation team, the Operator's hazard register did not contain those hazards. The only records shown in the hazard register were logs of occurrences (incidents/accidents). The investigation also found that there was no record of a hazard and risk assessment conducted at Tekin Airstrip prior to P2-BWC operating into Tekin a week after a similar accident involving P2-BWE. The investigation concluded that the SMS was not being adequately implemented to the appropriate extent.

This has been identified as a risk to the continued operations of the Operator as its pilots are operating into certain airstrips, including Tekin, for which the existing risks are not being managed by the Operator.

2.1.3.3 Customs Policy

Air Fleet Management personnel informed the AIC that he had verbally informed the new Central Aviation Maintenance Controller of the Custom Policy relating to the MLG attachment bolts. However, there was no evidence to verify this information. The investigation determines that even if it was verified to have been passed verbally, this would not have been the appropriate method to use for transferring such vital maintenance information.

The Operator did not have a custom policy, nor were there any provision in their maintenance documentation that refer to a custom policy requirement. The investigation determined that the tracking system was not handed over to the Maintenance Controller of Central Aviation, subsequently, Central Aviation did not transfer any information regarding the Custom Policy to NASL.

The investigation determined that due to the lack of provision in the Operator's maintenance documentation in relation to a custom policy requirement, the Operator was unaware of the Custom Policy, especially the MLG attachment bolts replacement.

2.1.4 Calibrated Tools and Equipment

The investigation found that the Operator had a register which listed and scheduled maintenance tools and equipment. The register did not contain pressure gauges used for the aircraft landing gear oleos and tyres. There were no records available for the calibration of these gauges. The accuracy of these measurement gauges at the time they had been using for servicing and maintenance could not be determined. The investigation determined that these gauges had not been checked and calibrated as long as the Operator has used them.

The aircraft came out from a scheduled maintenance three days before the accident. The MLGs were also subject for inspection, servicing, and maintenance as per the schedule.

The gauges were sent by the Operator to NISIT with 'unserviceable' tags on 27 July 2022. NISIT stated to the AIC that they had subsequently calibrated the equipment and sent them back to the Operator. The investigation could not determine whether the tyre pressure, and/or oleos pressure gauge's tolerance as there was no reliable evidence to help in the assessment.

The investigation is aware that the same gauges were being used to service the landing gear of this accident aircraft were the same gauges used for P2-BWE, the aircraft involved in an accident eight days prior. The AIC believes that these gauges may have been outside of tolerance causing inaccurate pressure readings during tyre pressure and oleo pressure checks and charging. There was no way of confirming this as the landing gear were compromised during the accident.

The AIC emphasizes that pressure gauges that are uncalibrated may cause over- or under-pressurization which will significantly affect the ability of the aircrafts dampening and shock absorption system from landing and rolling impact forces. This allow the transfer of landing impact forces up to other components which are designed to sustain such forces risking sudden failure, or, at least, wear and tear leading to failure over time.

2.2 Search and Rescue

The investigation noted that there was a two-way communication between ATS and the pilot. The ATS made several radio calls to locate P2-BWC and following no response from the pilot, the ATC contacted P2-SBS to call P2-BWC. The investigation determined that, ATS could not reach the aircraft, it allowed the helicopter to make radio call within the Kiunga circuit area as the P2-BWC made the call while on cruise after departing Kiunga Airport.

The pilot said to make a call after landing to cancel the SAR watch. However, the pilot did not call back. The investigation determined that right after the accident the pilot was focused on evacuating the passengers immediately and did not call back to ATS to cancel SARWATCH however following a call from the Operator's agent, the Operator contacted the ATS and the SARWATCH was cancelled.

Investigation notes that the carriage of a serviceable ELT on aircraft in PNG is mandated for the safety of the aircraft occupants in the event of an aircraft accident away from habited areas. The ELT was not activated when the aircraft impacted the strip surface on landing.

The investigation determined that the ELT battery was expired and still fitted on the aircraft for eight months before the accident. Due to low battery power, the ELT could not be able to activate itself following the aircraft MLG impacting on the strip surface.

Because a serviceable ELT is a requirement for the safe operation of the aircraft in PNG, an expired ELT battery rendered the aircraft unserviceable.

3 CONCLUSIONS

3.1 Findings

3.1.1 Aircraft

- a) The aircraft was certified, equipped and maintained in accordance with existing regulations and approved procedures.
- b) The aircraft had a valid Certificate of Airworthiness and had been maintained in compliance with the regulations.
- c) Aircraft ELT Battery was expired and fitted to the aircraft.
- d) The aircraft was not airworthy when dispatched for the flight.
- e) There was no evidence of any defect or malfunction prior to the accident.
- f) There was no evidence of airframe failure or system malfunction prior to the accident.
- g) The aircraft was structurally intact prior to impact.
- h) All control surfaces were accounted for and all damage to the aircraft was attributed to the severe impact forces.
- i) The MLG was detached after touched down and before the aircraft came to a rest.
- j) ELT Battery expired before the accident date.

3.1.2 Pilot

- a) The flight pilot was properly licensed and qualified for the flight in accordance with existing regulations.
- b) The pilot was properly licensed, medically fit and adequately rested to operate the flight.
- c) The pilot was in compliance with the flight and duty time regulations.
- d) The pilot made three landings into Tekin including the accident flight.
- e) The pilot's actions and statements indicated that his knowledge and understanding of the aircraft systems was adequate.

3.1.3 Flight operations

- a) The flight was conducted in accordance with the procedures in the company Operations Manual.
- b) The pilot carried out normal radio communications with the relevant ATS units.
- c) The impact force exerted on the left MLG subsequently separated the MLG assembly from the aircraft wing structure.
- d) The aircraft lost control and had a runway excursion after the left MLG detached on landing.

3.1.4 Operator

- a) The Operator did not conduct a risk assessment on the last similar accident into Tekin airstrip.
- b) The pilot was not checked into Tekin airstrip.
- c) The Operator did not have any records in their Hazard Register for Tekin Airstrip
- d) The Operators tools and equipment calibration register did not contain the gauge and regulator for the tyre pressurisation and checking equipment

- e) The Operator did not have the records of the for Tyre Deflator and the Nitrogen regulator Gauges.

3.1.5 Airstrip

- a) The airstrip was suitable for normal take-off and Landing

3.1.6 Air Traffic services and airport facilities

- a) ATS provided prompt and effective assistance to the pilot.

3.1.7 Flight Recorders

- a) The aircraft was not equipped with a FDR or a CVR; neither was required by the regulation.

3.1.8 Medical

- a) There was no evidence that incapacitation or physiological factors affected the pilot performance.
- b) There was no evidence that the pilot suffered any sudden illness or incapacity which might have affected his ability to control the aircraft.

3.1.9 Survivability

- a) The accident was survivable due to the low level of severity of impact.
- b) The pilot and the passengers egressed the aircraft without injuries and external assistance.
- c) The pilot did not cancel SARWATCH after the accident which resulted in a declaration of INCERFA by ATS.
- d) The INCERFA phase was cancelled when the Operator contacted ATS, after being informed about the accident.
- e) ELT Unit was not activated.

3.1.10 Safety Oversight

- a) CASA PNG registry did not contain records of the pilot in their registry.

3.2 Causes [Contributing factors]

During the landing at Tekin Airstrip, the pilot encountered downdraft and touchdown about 4m short of the designated landing threshold. Due to less damping effect on the oleo or the tyre, the landing impact force could have transferred up through the structure and concurrently causing the left main landing gear to collapse. Subsequently, the left wing abruptly dropped and began veering to the left, towards the eastern edge of the airstrip.

The aircraft continued veering to the left and subsequently the left wingtip struck the outer edge of the extended right-side flap of P2-BWE, causing it to abruptly veer further left and skid across the airstrip boundary as the nose-wheel and right main wheel bogged into the ground.

3.3 Other factors

The investigation found non-contributory safety deficiencies. These are addressed in the factual and safety recommendations.

Intentionally Left Blank

4 RECOMMENDATIONS

4.1 Recommendations

As a result of the investigation into the accident involving P2-BWC, the Papua New Guinea Accident Investigation Commission issued the following recommendations to address concerns identified in this report.

4.1.1 Recommendation number AIC 22-R01/22-1002 to CASA PNG.

The AIC recommends that the Civil Aviation Safety Authority of PNG prohibit operators from conducting fixed wing flights into Tekin Airstrip until the responsible parties cause the airstrip to be re-evaluated and deemed safe for such operations.

4.1.2 Recommendation number AIC 22-R02/22-1002 to CASA PNG.

The AIC recommends that the Civil Aviation Safety Authority of PNG ensure that appropriate action is taken to ensure it is satisfied that the Operator, Niugini Aviation Services Limited, meets the minimum safety standards before resuming normal operations.

4.1.3 Recommendation number AIC 22-R03/22-1002 to Sandaun Provincial Government.

The AIC recommends that the Sandaun Provincial Government:

- a) engage an appropriate party, such as the Rural Airstrips Agency (RAA), to take appropriate actions to ensure Tekin Airstrip meets the acceptable safety levels for fixed wing operations.
- b) cause the dissemination of results and data to CASA PNG and Operators for risk assessment and mitigation.

4.1.4 Recommendation number AIC 22-R09/22-1001 to Minister for Transport and Civil Aviation.

The PNG Accident Investigation Commission recommends that the Minister for Transport and Civil Aviation should:

1. take note of the safety concern in regard to aircraft accidents in PNG rural airstrip according to the 2010-2022 accident data provided,
2. ensure that this safety concern is brought to the attention of the Provincial Governments, where applicable, through the Department of Provincial Affairs and Local-level Government Affairs to;
 - a) engage an appropriate party, such as Rural Airstrip Agency (RAA) to ensure airstrips are properly assessed and the data is represented accurately for safety of fixed wing aircraft operations and that the airstrips, and
 - b) cause the dissemination of the result and data to CASA PNG and the Operator to support operational risk assessment.

Intentionally Left Blank

5 APPENDICES

5.1 Appendix A: Service Bulletin PACSB/XL/105 Issue 4

PACIFIC AEROSPACE

Pacific Aerospace Limited
Airport Road, Hamilton
Private Bag 3027, Hamilton 3240, New Zealand
TEL: +64 7 843 8144 FAX: +64 7 843 8134
EMAIL: pacific@aerospace.co.nz
WEB: www.aerospace.co.nz

MANDATORY SERVICE

PACSB / XL / 105
ISSUE 4

B
U
L
L
E
T
I
N

INSPECTION – NLG / MLG – PALNUTS

1. PLANNING INFORMATION

A. EFFECTIVITY

<u>Part A/B</u>	<u>S/N</u>
<u>MODEL</u>	
750XL (NZ)	Up to S/N 216, and S/N 220
750XL (CN)	8001 and 8002

<u>Part C</u>	<u>S/N</u>
<u>MODEL</u>	
750 (NZ)	Up to S/N 185 (excluding S/N 177)

B. REASON

To replace the Nose Landing Gear attachment fasteners: installing castellated nuts and locking pins; replacing the friction locking nuts previously installed

To inspect the Main Landing Gear attachment bolts and installing Palnuts as required

Issue 4 adds alternatives to the bolt P/N NAS6606D63 and NAS6606D66.

C. DESCRIPTION

Part A – Daily until Part B is completed.
Inspect the NLG lower bolts and clamp for security
Replace nuts if found loose

Part B – Procedures for replacement of locking nut and pal nut with a castellated nyloc locking nut and split pin in Nose Landing Gear

Part C – Procedures for inspection and installation of Palnuts on the 3/8 bolts in the Main Landing Gear of the Short range wing and the 7/16 bolts of aircraft embodied with MOD PAC/XL/ 0451, 0509 and 0663)

NOTE. Part C is not applicable for Extended Range Wing aircraft (which were all fitted with Palnuts during manufacture)

Issue 4: 19 December 2018Page 1 of 10

- | | |
|-------------------------------------|--|
| D. <u>COMPLIANCE</u> | Part A: Daily until Part B is accomplished.
Part B/C: Within the next 165 flight hours. |
| E. <u>APPROVAL</u> | By delegated authority. |
| F. <u>TOOLING</u> | N/A. |
| G. <u>WEIGHT AND BALANCE</u> | No change. |
| H. <u>REFERENCE</u> | AMM Supplements PAC/XL/0389, 0451,
0509, 0663 and 750XL Maintenance
Manual. |
| I. <u>HOURS REQUIRED</u> | Part A – 2 Min.
Part B – 1 Hour.
Part C – 4 Hours. |
| J. <u>WARRANTY COVER</u> | Normal warranty conditions apply. |

2. PART A – INSPECTION INSTRUCTIONS

NOTE: The initial inspection (Steps 1 to 4) should be performed by a qualified and approved LAME.

- 1) Inspect the lower attachment bolts on the nose landing gear.
- 2) Check for loose bolts and gaps between the clamp and firewall.
- 3) If the bolts or the clamp look or feel loose, you must proceed to Part B prior to operating the aircraft.
- 4) Upon first inspection, add torque stripe at bolt head checking daily for relative movement.

NOTE: Daily visual inspections (Step 5) may be performed by a qualified pilot.

- 5) Check daily if there is any misalignment on the stripe added in Step 4. If there is, you must proceed to Part B prior to operating the aircraft.

3. PART B - ACCOMPLISHMENT INSTRUCTIONS (NOSE LANDING GEAR)

- 1) Raise the nose Landing Gear of the ground (or alternatively, depressurise the nose Landing Gear).
- 2) Remove LH or RH Cockpit Seats (Ref. 750XL MM, Section 25-10-00 or AMM Supplement PAC/XL/0389 - MCI Model 2023 Crew Seats).
- 3) Remove the Hose Clip from the Diffuser Cockpit Footwell in the Cover Panel Assembly - Centre, if PAC/XL/0182 – Bleed Air Cabin Heater is installed (See Figure 1).



DIFFUSER COCKPIT FOOTWELL (REF)

FIGURE 1 COCKPIT FLOOR – DIFFUSER COCKPIT FOOTWELL (IF INSTALLED)

- 4) Remove the Cover Panel Fwd of the Cover Panel Assembly - Centre P/N 11-16365-1 (See Figure 2).

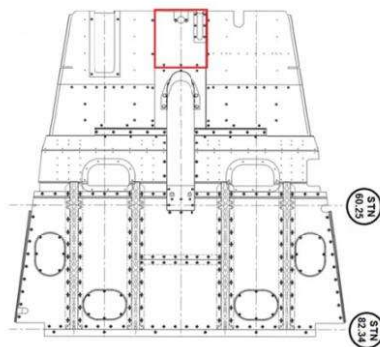

FIGURE 2 COCKPIT FLOOR (ONLY FOR REFERENCE)

- 5) Remove the Upper Engine Cowl to get access to the upper attachment area of the Nose Landing Gear (Ref. 750XL MM, Chapter 71).
- 6) Replace existing hardware with the following:
 - Bolts – NAS6606D63 or alternate parts (refer to Section 6. Material List)
 - Nuts – MS17825 – 6 [Torque to 160-260 lb.in]
 - Spring Pin / Split Pin – AN416-2 or MS24665-283

NOTE: The Bolts P/N NAS6606D63 may be fabricated from P/N NAS6606-63 iaw PAL DWG BOL6606 (refer to the attached drawing).

NOTE: The Bolts P/N NAS6606D64 may be fabricated from P/N NAS6606-64 iaw PAL DWG BOL6606 (refer to the attached drawing). If using this bolt you must use an additional washer P/N AN960-616 directly behind the nut.

- 7) In the Lower Engine Cowl area, access the lower attachment bolts of the Nose landing gear.
- 8) Replace existing hardware with the following:
 - Bolts – NAS6606D68 or alternate parts (refer to Section 6. Material List)
 - Nuts – MS17825 – 6 [Torque to 160-260 lb.in]
 - Spring Pin / Split Pin – AN416-2 or MS24665-283

NOTE: The Bolts P/N NAS6606D68 may be fabricated from P/N NAS6606-68 iaw PAL DWG BOL6606 (refer to the attached drawing).

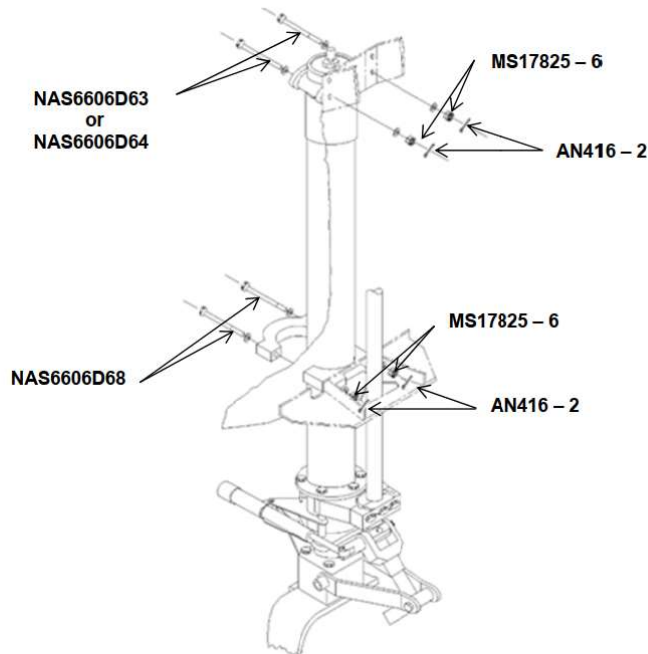

FIGURE 3 NOSE LANDING GEAR – HARDWARE REPLACEMENT

- 9) Reinstall the Upper Engine Cowl (Ref. 750XL Maintenance Manual, Chapter 71).
- 10) Reinstall the Hose Clip to the Diffuser Cockpit Footwell in the Cover Panel Assembly - Centre, if PAC/XL/0182 – Bleed Air Cabin Heater is installed (See Figure 1).
- 11) Reinstall LH or RH Cockpit Seats (Ref. 750 XL MM, Section 25-10-00 or AMM Supplement PAC/XL/0389 - MCI Model 2023 Crew Seats).
- 12) Check NLG Oleo pressure (Ref. 750XL MM, Section 12-70-00).
- 13) Carry out nose wheel shimmy check (Ref. 750XL MM, Section 32-50-00).

4. PART C - ACCOMPLISHMENT INSTRUCTIONS (MAIN LANDING GEAR)

- 1) Remove the Leading Edge Protection Panels (LH / RH) (Ref. 750XL MM, Section 51-90-00).
- 2) Remove the Lower Inner Protection Panels (LH / RH) (Ref. 750XL MM, Section 51-90-00).



FIGURE 4 LOWER WING SURFACE (SHORT RANGE WING)

- 3) Remove the Inboard and Outboard Cover Panels (LH / RH) (See Figure 5) (Ref. 750XL MM, Section 32-10-00).

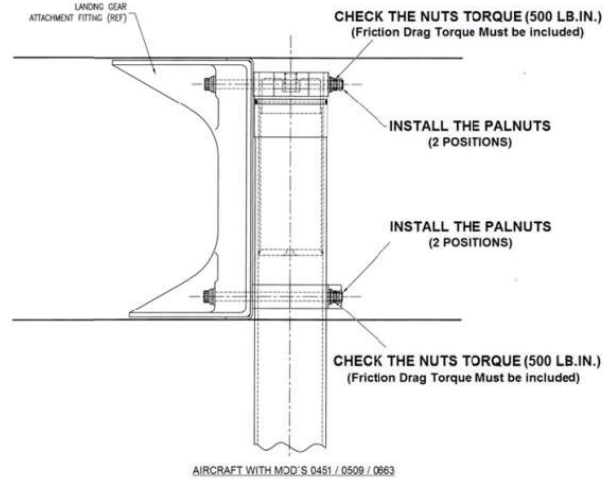

FIGURE 8 MAIN LANDING GEAR (AIRCRAFT WITH MODS 0451 / 0509 / 0663) – TORQUE CHECK AND PALNUTS INSTALLATION

5. CERTIFICATION

Record compliance with Part A, Part B and/or Part C of this bulletin in the Aircraft Log Book. Completion of Part B and Part C (if applicable) is terminating action to this Service Bulletin.

6. MATERIAL REQUIRED

PART B - NOSE LANDING GEAR

<u>Description</u>	<u>Part Number</u>	<u>Qty Required</u>
BOLT	NAS6606D63	2
	OR	
	NAS1306-63D	
	OR	
	PAL BOL6606D63	
	OR	
	NAS6606-63 (hole drilled iaw PAL DWG BOL6606)	
	OR	
	NAS6606D64	
	OR	
	PAL BOL6606D64	
	OR	
	NAS6606-64 (hole drilled iaw PAL DWG BOL6606)	

BOLT	NAS6606D68 OR NAS1306-68D OR PAL BOL6606D68 OR NAS6606-68 (hole drilled iaw PAL DWG BOL6606)	2
NUT	MS17825 – 6	4
SPRING PIN OR SPLIT PIN	AN416-2 OR MS24665-283	4
WASHER **	AN960-616	2 (if applicable)

** An additional washer P/N AN960-616 is installed only with the Bolts P/N NAS6606D64 or alternative bolts.

PART C - MAIN LANDING GEAR

<u>Description</u>	<u>Part Number</u>	<u>Qty Required</u>
PALNUT (SHORT RANGE WING AIRCRAFT)	MS27151-19	A/R (MAX. 8)
<u>OR</u>		
PALNUT (MODS 0451, 0509 AND 0663)	MS27151-21	A/R (MAX. 8)

NTENTIONALLY LEFT BLANK

BOLTS

1. COMMENTS ON THIS DRAWING TO BE MADE BY ACCORDANCE WITH COMPANY APPROVED MANUFACTURING STANDARDS AND PROCEDURES.

2. MANUFACTURE FROM: NAS6603-xx THRU NAS6620-xx OR NAS6603-xxX THRU NAS6620-xxX

ALL DIMENSIONS TO CONFORM TO THE EQUIVALENT INHS SPECIFICATIONS, PROVIDED DIMENSIONS REF ONLY

VIKING ETCH OUT MANUFACTURER'S MARK AND MARK WITH PAL MARK WHERE INDICATED

DOTTER FIN HOLE CENTRELINE WITHIN .010 AND NORMAL WITHIN 2" OF BOLT CENTRELINE

"NOL" REPLACES "NAS" FOR THE DRILLED BOLT PART NUMBER AND "D" AFTER BASIC PART No. FOR DRILLED SHANK BOLTS. ADD "M" AFTER BASIC PART No. FOR DRILLED HEAD BOLTS.

Ex: WHERE DRILLED HEAD BOLT IS MANUFACTURED FROM NAS6603-xx BOLT THE NEW PART NUMBER IS BOL6603Hxx

Ex: WHERE DRILLED HEAD BOLT IS MANUFACTURED FROM NAS6603-xxX BOLT THE NEW PART NUMBER IS BOL6603HxxX

Ex: WHERE DRILLED SHANK BOLT IS MANUFACTURED FROM NAS6603-xx BOLT THE NEW PART NUMBER IS BOL6603Dxx

WHERE xx = GRIP DASH NUMBER

DRILLED BOLTS TO BE PROTECTED BY APPLICATION OF CRC 3-36 CORROSION INHIBITING COMPOUND OR EQUIVALENT CONFORMING TO NI-C-BL3006, APPLIED TO THE HEADS AND DRILLED HOLES.

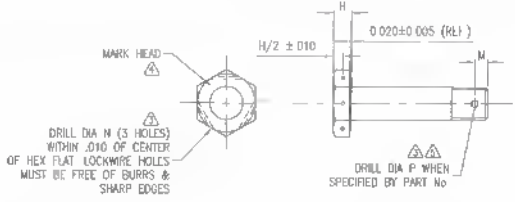

NEW BASIC NUMBER	ORIGINAL BASIC NUMBER	H (REF) - #13 - #10	M ± 0.10	N DIA ±.010 - .008	P DIA - #15 - .009
BOL6603	NAS6603	110	164	.046	.070
BOL6604	NAS6604	125	178	.046	.070
BOL6605	NAS6605	154	181	.070	.070
BOL6606	NAS6606	188	197	.070	.106
BOL6607	NAS6607	218	201	.070	.106
BOL6609	NAS6609	250	216	.070	.106
BOL6609	NAS6609	261	218	.070	.141
BOL6610	NAS6610	312	248	.070	.141
BOL6612	NAS6612	375	252	.070	.141
BOL6614	NAS6614	438	257	.070	.141
BOL6616	NAS6616	500	268	.070	.141
BOL6618	NAS6618	562	307	.070	.141
BOL6620	NAS6620	625	358	.070	.141

IF IN DOUBT ASK

ITEM	PART NUMBER	DESCRIPTION	SIZE	SPECIFICATION	NEXT ASSY
A	HC	ISSUE	PACIFIC AEROSPACE		DRILLS CHECKED
A1	CHANGE NO	AIRPORT ROAD HAMILTON NEW ZEALAND			SPECIFIED
DETAILS FOR DRILLED SHANK BOLTS ADD	CHANGE	THIS DRAWING IS THE PROPERTY OF PACIFIC AEROSPACE LIMITED AND MAY NOT BE COPIED OR USED FOR ANY PURPOSE OTHER THAN THAT FOR WHICH IT IS SUPPLIED WITHOUT THE EXPRESS WRITTEN AUTHORITY OF PACIFIC AEROSPACE LIMITED. © 2014			THIS ASSY PROJECT NUMBER
	FINISH	NOTED	DRAWN	G. JONES	20-08-14
	WEIGHT	-	CHECK	R.L. BECK	22-05-14
	SCALE	N.T.S.	STRESS		
	MFG	-	APPROVAL	AvR	22-05-14
CAN	DRAWN	DESCRIPTION			DRAWING NUMBER
DATE	APP'D	DRILLED NAS6603 THRU 6620 SERIES BOLTS			BOL6603 THRU 6620
DATE					SHEET 1 OF 1

5.2 Appendix B: MLG Oleo Servicing

LANDING GEAR

12-60-00

1. MAIN LANDING GEAR OLEO SERVICING

- (1) Place aircraft on jacks
- (2) Remove valve cap from inflation and place a length of plastic tubing over the threaded portion of the valve and place the free end into a container.
- (3) Reduce the gas pressure in the oleo by slowly slackening the locking nut until no pressure remains.

NOTE: Some oil will exit with the gas. Repeat the process for the opposite undercarriage.

- (4) If available, place a spacer 3.75" in length between the bearing retainer plate and the socket.
- (5) Simultaneously lower the jacks until the MLG have compressed onto the spacers. Without spacers, compress legs until a dimension of 3.75" is achieved between bearing retainer plate and the socket.
- (6) Remove the inflation valve.
- (7) Place a standpipe into the aperture where the valve was removed and fill with Mil-H-5606 fluid.
- (8) Replace the inflation valve with new "O" ring and torque.
- (9) Connect Dry Nitrogen source to inflation valve and carefully inflate to a pressure of 100PSI (repeat for opposite side).
- (10) Jack the aircraft until both main wheels are clear of the ground and inflate with dry nitrogen to 350 – 450 PSI torque locking nut, disconnect inflater and refit valve cap.

2. NOSE LANDING GEAR OLEO SERVICING

- (1) Place aircraft on jacks.
- (2) Remove engine cowls.
- (3) Remove valve cap from inflation valve and place a length of plastic tubing over the threaded portion of the valve and place the free end into a container.
- (4) Reduce the gas pressure in the oleo by slowly slackening the locking nut until no pressure remains.

NOTE: Some oil will exit with the gas.

- (5) Place a spacer 5.25" in length between the bearing retainer plate and the socket.
- (6) Simultaneously lower the jack until the nose undercarriage has compressed onto the spacer.
- (7) Remove the lock-wire from the inflation valve and remove the valve assembly.
- (8) Place a standpipe into the aperture where the valve was removed and fill with Mil-H-5056 fluid.
- (9) Replace the inflation valve with new "O" ring, torque and lock-wire.
- (10) Connect Dry Nitrogen source to inflation valve and carefully inflate to a pressure of 100PSI.
- (11) Jack the aircraft until nose wheel is clear of the ground and inflate with dry nitrogen to 160 - 190 psi, until steering block is approximately parallel with the ground. Torque locking nut, disconnect inflater and refit valve cap.

5.3 Appendix C: Maintenance on MLG

PACIFIC AEROSPACE		750XL MAINTENANCE MANUAL						
		CHAPTER 05						
SYSTEM/STRUCTURE	Landing Gear	FREQUENCY			ENG/ MECH	INSP	SPECIAL REQUIREMENTS AND REFERENCES	
CHAPTER REF.	32	CHECK NO.						
ITEM	OPERATION	1	2					
Main Landing Gear Struts	a) Examine rams for condition and leaks.	*					430 in.lb. (Friction drag torque must be included)	
	b) Clean exposed rams.	*						
	c) Check leg extension.	*						
	d) Clean landing gear.	*						
	e) Examine attachment points for security, condition and distortion. Check bolt torque.	*						
	f) Examine torque links attachment lugs for cracks.	*						
	g) Check oil contents.	*	*					
	h) Inflate struts.	*						350 to 450 psi (Refer Chapter 12-60-00)
	i) Examine axle for security.	*						210-250 in.lb.
	j) Check collar bolt (upper torque link attachment) torque.	*						
Torque Links	a) Examine for security and damage.	*						
	b) Examine bumper for wear.	*						
	c) Remove assemblies and check for wear.	*	*					
	d) Lubricate.	*						
Nose Landing Gear Strut	a) Examine ram for damage and leaks.	*					160 to 190 psi (Refer Chapter 12-60-00)	
	b) Clean exposed ram.	*						
	c) Check leg extensions.	*						
	d) Clean landing gear.	*						
	e) Examine attachment points for security, condition and distortion.	*						
	f) Examine torque steering link attachment for wear / cracks.	*						
	g) Lubricate torque link centre pin.	*						
	h) Examine nosewheel fork for security.	*	*					
	i) Examine restraining cables for condition.	*						
	j) Check oil content.	*						
	k) Inflate strut.	*						

Ref: MAINT. SCH
 ENG/MECH = Engineer/Mechanic INSP. = Inspector

Issued: October 2013 Page 613

05-10-00

AD's and Inspections Worksheet

Naval Aviation (Class COA - 148/863)

Aircraft: 750L
 Base: F2-BWC
 Serial #: 136
 Job No: 804061

Co-maintainer Signature: _____
 Maint Name: John Ford
 Date: 14/01/22
 License No: A2000

Component: _____
 Quantity: _____
 Airframe: _____
 Hours: 6746.3
 Days: 13-01-2022

Work Required	Action Taken	ATA Code
MAIN LANDING GEAR ATTACH BRACKET (100) PAC/14/0212 MAIN LANDING GEAR ATTACH BRACKET (201)	Task No 017 Category Airframe Monitor By Hours Interval 150 Due 6746.3 To Run 0	ATA Code 30-00
	Inspection c/o IAW PAC/14/0212 All Satis, Nil Defects Found	AJLE LAJLE License No G Date 14/01/22 Labour Hours 1
GROUND POWER CIRCUIT PROTECTION (200) PAC/14/0212 GROUND POWER CIRCUIT PROTECTION (200)	Task No 018 Category Airframe Monitor By Hours Interval 150 Due 6746.3 To Run 0	ATA Code 30-00
	Ground Power Protection Divide Checks c/out satisfactory IAW PAC/14/0212 Nil Evidence of Abnormality	AJLE LAJLE License No G Date 15/01/2022 Labour Hours 10
RF 1050 RADIO SYSTEM (100) PAC/14/0321 RF 1050 RADIO SYSTEM (100)	Task No 019 Category Airframe Monitor By Hours Interval 150 Due 6746.3 To Run 0	ATA Code 30-00
	RF 1050 Radio System Checked & Radio Calls c/out Satisfactory IAW PAC/14/0321 Nil Evidence of any abnormal ops	AJLE LAJLE License No G Date 15/01/2022 Labour Hours 10
INSTALLATION OF AFT STORAGE COMPARTMENT (100) PAC/14/0367 INSTALLATION OF AFT STORAGE COMPARTMENT (100 P1) (200)	Task No 020 Category Airframe Monitor By Hours Interval 150 Due 6746.3 To Run 0	ATA Code 30-00
	AFT STORAGE COMPARTMENT INTERNAL COMPARTMENT INSPECTED FOR CONDITION, FASTENERS FOR SECURITY & CONDITION, ICE STRAPPING NET & ATTACH POINTS FITTED/REMOVE PLATE FOR SECURITY & CONDITION. ALL INSPECTIONS CARRIED OUT IAW PAC 700 MAINTENANCE MANUAL SUPPLEMENT PAC/14/0367 NIL DEFECT EVIDENT	AJLE LAJLE License No G Date 14/01/22 Labour Hours 1

The maintenance recorded has been carried out in accordance with the requirements of Papua New Guinea Civil Aviation Rule Part 41 and in respect of that aircraft.
 (*Particulars) (*Assignment) as Released to Service. *Date as applicable

Page No: _____ Page 1 of 15

NAME: _____ SIGNATURE: _____ DATE: 17/01/22

AD's and Inspections Worksheet

Niugini Aviation Services COA - 145/063

Aircraft : 750L
 Rego : P2-BWC
 Serial # : 136
 Job No : N690051

Co-ordinators Signature : _____

Print Name : _____

Date : 14/01/22

Licence No : AE22069

Component Counter
 Airframe Hours
 Airframe Days

Total
 6745.3
 13-01-2022

Work Required : INSTALLATION WIDE MAIN TYRES 150H PAC/XL/0387 INSTALLATION WIDE MAIN TYRES (3210)		ATA Code : 32-00
Task No 021 Category Airframe Monitor By Hours Interval 150 Due 6745.3 To Run 0	Action Taken : MAIN TYRES VISUALLY INSPECTED FOR CUTS, FLAT SPOTS, TREAD OR SIDEWALL DAMAGE, CORRECT INFLATION PRESSURE AND VALVE STEM FOR DAMAGE & CORRECT ALIGNMENT. INSPECTION CARRIED OUT IN ACCORDANCE WITH MAINTENANCE MANUAL SUPPLEMENT PAC/XL/0387 FOUND SATISFACTORY	A.M.E _____ L.A.M.E _____ Licence No SA 2 Date 17/01/22 Labour Hours 2
Work Required : REPAIR DRIVE LEVER 11-31033 150H PAC/XL/0442 REPAIR DRIVE LEVER 11-31033 ELEVATOR TRIM TAB (2730)		ATA Code : 72-00
Task No 022 Category Airframe Monitor By Hours Interval 150 Due 6745.3 To Run 0	Action Taken : INSPECTION SHOW 170N PAC/XL/0442 SUPPLEMENT PAC/XL/0442 NIL DEFECT EVIDENT	A.M.E _____ L.A.M.E _____ Licence No SA ; Date 17/01/22 Labour Hours 1
Work Required : STONE DEFLECTORS - MAIN LANDING GEAR 150H PAC/XL/0458 STONE DEFLECTORS - MAIN LANDING GEAR (WIDE TYRES) (3200)		ATA Code : 32-00
Task No 023 Category Airframe Monitor By Hours Interval 150 Due 6745.3 To Run 0	Action Taken : STONE DEFLECTOR STRUCTURE INSPECTED FOR CORROSION & CONDITION PARTENERS FOR SECURITY, CHECKED FOR CLEARANCE FROM TYRE, NEW RUBBER FLAPS INSTALLED. ALL WORK DONE IN ACCORDANCE WITH MAINTENANCE MANUAL SUPPLEMENT PAC/XL/0458	A.M.E _____ L.A.M.E _____ Licence No L Date 17/01/22 Labour Hours 2
Work Required : ENGINE SCAVENGE OIL PUMP INLET SCREEN 200H / 6M ENGINE SCAVENGE OIL PUMP INLET SCREEN (7261)-(OO WITH PWC TASK)		ATA Code : 72-00
Task No 026 Category Airframe Monitor By Hours, Months Interval 200 Due 6795.3, 18-05-2022 To Run 50	Action Taken : C/O SATIS REF TASK 43	A.M.E _____ L.A.M.E _____ Licence No _____ Date 20/01/21 Labour Hours 2

The maintenance recorded has been carried out in accordance with the requirements of Papua New Guinea Civil Aviation Rule Part 43 and in respect of that maintenance the Aircraft is Released to Service. *delete as applicable

Form No :

Page 6 of 15

NAME : _____

SIGNATURE : _____

AUTH : _____

DATE : 20-01-22

5.4 Appendix D: CASA PNG AC 139-6

CHAPTER 3 — Obstacle Limitation Surfaces

3.1 General

3.1.1 Each runway/strip should be provided with take-off climb and approach surfaces, such that aeroplanes taking off, or landing have a clear obstacle-free surface over which to carry out the initial phase of the climb, or final part of the approach.

3.1.2 Any boundary fence or hedge should be sited so as not to penetrate the take-off climb/approach surface.

3.2 Take-off Climb/ Approach Surface

3.2.1 Each runway should have a takeoff climb and approach surface which should:

- Rise from the end of the runway strip; and
- Be obstacle free above a gradient of 1:20 (5%) and
- Extend horizontally 600m from the inner edge and
- Have sides that are splayed outwards at the rate of 1:20 (5%) and
- Not turn before 300 m from the inner edge, if a turn is necessary.

3.2.2 If the 1:20 (5%) gradient rising from the runway strip end does not clear all obstacles, a displaced landing threshold should be marked at the position necessary to ensure that the approach surface clears the obstacles. Refer to section 2.1.7.

3.3 Transitional Side Surface

3.3.1 Each runway strip should have a surface clear of obstructions extending sideways and upwards from the sides of the runway strip and the approach/take-off surfaces. The surface should be at a gradient of 1:5 (20%) till it reaches a height of 2 m above the runway strip. Refer to figure 3-1 for a depiction of obstacle limitation surfaces.

Note: When allowance for the transitional side surface obstacle limitation requirements are taken into account, this increases the width of the runway environment to 40 m. Refer to figure 3.1.

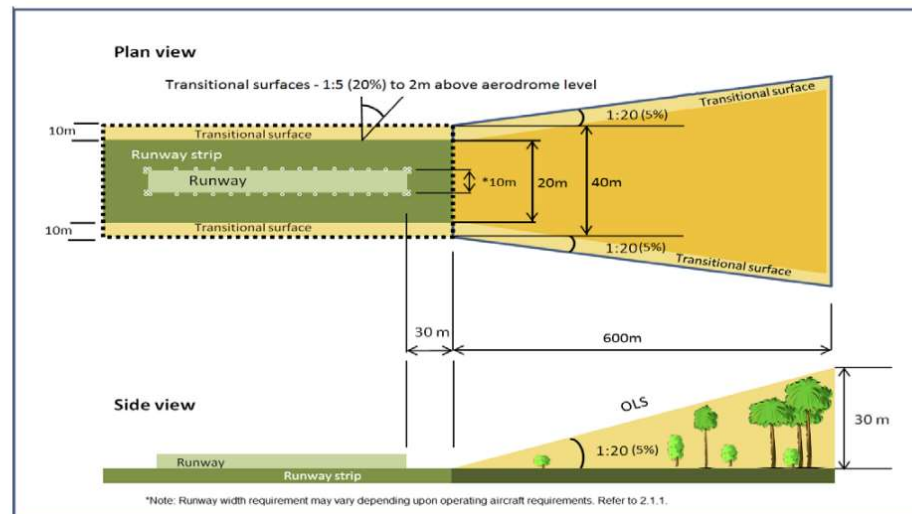

Figure 3-1 - Obstacle limitation surfaces

Runway end markers

5.2.2 On unpaved runway/strip, runway/strip end markers should be an L shaped group of 3 white cone markers located at each runway end corner, for a total of 4 end markers per runway. Two runway end markers are shown at figure 5-2.

Note: End markers can suffice for runway threshold markers where both the end of the runway and the threshold are co-located.

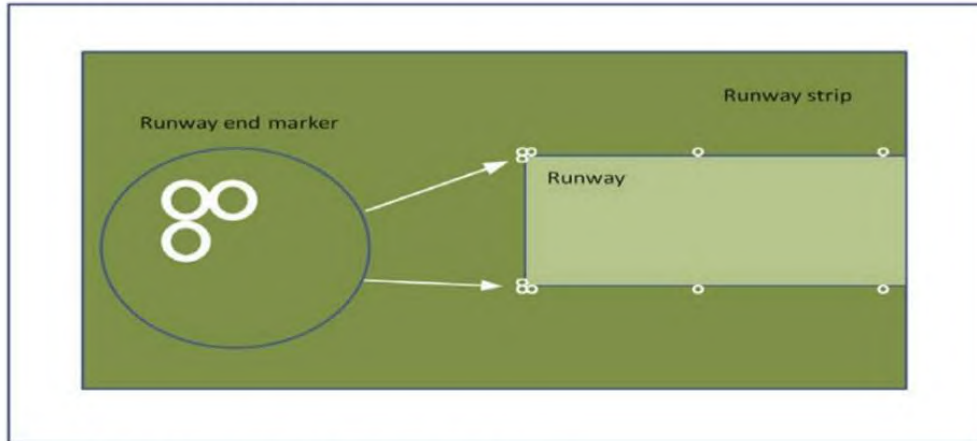

Figure 5-2. Runway end markers on unpaved runways

Displaced threshold

5.2.3 On unpaved runways, displaced threshold markers should be indicated by a row of 3 cones on either side of a runway at right angles to the centreline, located at the beginning of that portion of the runway useable for landing, as indicated in figure 5-4.

Note: The portion of runway between the runway end markers and the displaced threshold is not available for landing

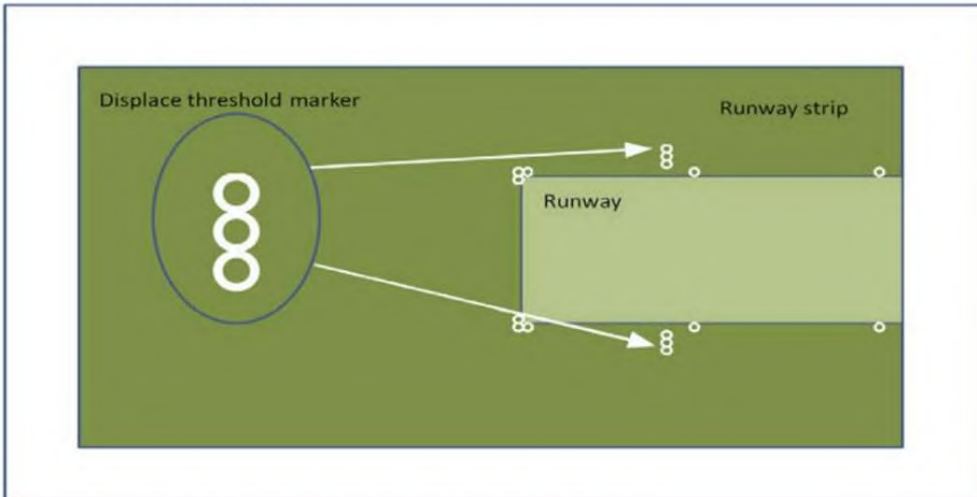



Figure 5-4. Displaced threshold markers on unpaved runways

5.5 Appendix E: NASL's approved Process for Calibration of Tools and Equipment

	MAINTENANCE ORGANISATION MANUAL	
SECTION 4 - TOOLS AND EQUIPMENT	Page 4-1	

4. SECTION 4 - TOOLS AND EQUIPMENT

4.1 Provision and Access

4.1.1 Purpose

To ensure that the correct tools and equipment are available as required for the maintenance being carried out.

4.1.2 Scope

All tools and equipment required to conduct maintenance on NAS 145 MOC aircraft.

4.1.3 Responsibilities

The Engineering Manager will provide adequate tools and equipment for maintenance activities conducted by NAS 145 MOC.

The Engineering Manager will ensure that appropriate and specified tools and equipment are on hand and serviceable for each maintenance activity carried out by the Maintenance Organisation.

4.1.4 Process

A. The Engineering Manager will identify all tools and equipment required for the scope of maintenance approved by CASA in section 1.3 of this manual and to ensure identified tools and equipment are:

1. Purchased made available to staff on site; or
2. In the case of infrequently used specialist tooling and equipment not held by the organisation, arrangements are made with a holder of such tooling and equipment to make it available when required.

B. NAS 145 MOC shall ensure All tools, equipment's and materials held by the organisation shall be available and easily accessible within the facility where maintenance activities performed or being carried out.

C. All tools and equipment are registered on form NA310 and NA311 and their maintenance and servicing due dates indicated.

D. The Engineering Manager will determine adequate and appropriate specifications for all tools and equipment requisitioned and ensure that no tools or equipment are purchased without his written authority.

4.1.5 References

Civil Aviation Rule 145.107(1)

4.1.6 Records

Equipment and Tool Registers – form NA310 & NA311.

5.6 Appendix F: Tekin Airstrip Survey

Airstrip name:	Tekin				
ICAO code:	AYTN	Date Surveyed:	21 May 2020		
Province:	West Sepik	Airstrip type:	<input checked="" type="checkbox"/> one-way <input type="checkbox"/> two-way		
Take-off direction:	358				
Co-ordinates (at parking bay):	S 05° 14.694'	Runway width:	11	m	
	E 142° 09.876'	Runway strip width:	24	m	
Elevation (at parking bay):	5842	ft	Runway length:	531	m
Elevation (at threshold):	5632	ft	Average overall slope:	9.6	%

Obstacle Limitation Surfaces (OLS)					
Transitional side surface (both sides) (AC139-6)					
20% side slope, clear for 2m above the runway strip:		<input checked="" type="checkbox"/> Yes <input type="checkbox"/> No/Non-serviceable ¹			
Additional Transitional side surface comments:					
Take-off/ Approach Surface (AC139-6)			For two-way airstrips only (AC139-6)		
5% up from the horizontal, 5% side splay (left & right), clear for 600m horizontally:		<input type="checkbox"/> Yes <input checked="" type="checkbox"/> No/Non-serviceable ¹		5% up from the horizontal, 5% side splay (left & right), clear for 600m horizontally:	
				<input type="checkbox"/> Yes <input type="checkbox"/> No/Non-serviceable ¹	
Additional 160m clearway			For two-way airstrips only		
At same grade as airstrip, clear for 160m, includes transitional side surface:		<input type="checkbox"/> Yes <input checked="" type="checkbox"/> No		At same grade as airstrip, clear for 160m, including transitional side surface:	
				<input type="checkbox"/> Yes <input type="checkbox"/> No	
160m from threshold, 5% up, 5% side splay (L&R), clear for 600m:		<input type="checkbox"/> Yes <input checked="" type="checkbox"/> No		160m from threshold, 5% up, 5% side splay (L&R), clear for 600m:	
				<input type="checkbox"/> Yes <input type="checkbox"/> No	
Critical obstacles (Take-off/Approach Surface and Clearway)					
Description:	Distance to obstacle (m):	Angle (%) above horizontal:	Description:	Distance to obstacle (m):	Angle (%) above horizontal:
Leaf tree RHS	135	0%			
Front tree	97	-3.5%			
Bright tree	66	-3.5%			
Tree L of group	101	-7.0%			
Tree	162	-3.5%			
Additional OLS or clearway comments:					

¹ In the configuration surveyed, without a displaced threshold, the airstrip is not compliant with AC139-6, and may not be safe for aircraft use. Alternative configurations may be possible including the use of a displaced threshold to avoid the obstacles.

Page - 1 Tekin Airstrip 21 May 2020

Surface Type and Condition				
Surface cover: (select one only)	<input type="checkbox"/> Paved	Soil type: (select one only)	<input checked="" type="checkbox"/> Fine-grain soil (silt, clay)	
	<input checked="" type="checkbox"/> Short grass		<input type="checkbox"/> Coarse-grain soil (sand, gravel)	
	<input type="checkbox"/> Long grass		Soil moisture:	<input type="checkbox"/> Dry
	<input type="checkbox"/> Patchy grass			<input checked="" type="checkbox"/> Moist
	<input type="checkbox"/> Bare			<input type="checkbox"/> Wet
<input type="checkbox"/> Overgrown	<input type="checkbox"/> Saturated /Non-serviceable ²			
Surface hardness: <i>If <u>Soft</u>, further investigation required</i>	<input type="checkbox"/> Soft/ Non-serviceable ²	Surface roughness:	<input type="checkbox"/> Inundated /Non-serviceable ²	
	<input type="checkbox"/> Medium		<input type="checkbox"/> Smooth	
DCP carried out:	<input checked="" type="checkbox"/> Yes		<input checked="" type="checkbox"/> Rough	
	<input type="checkbox"/> No		<input type="checkbox"/> Very rough/ Non-serviceable ²	
Surface undulation/ evenness comment:	Sections with some undulations			
Parking bay surface and condition comments:	Good, firm, grass and gravel			
Other surface comments:	Rough in general, but rougher in the steeper section			

Visual Aids for Navigation			
Windsock present:	<input checked="" type="checkbox"/> Yes x2 <input type="checkbox"/> No	Marker cones delineate the runway	<input checked="" type="checkbox"/> Yes <input type="checkbox"/> No
Windsock Setout:	<input type="checkbox"/> Complying <input checked="" type="checkbox"/> Non-complying	More marker cones required	<input checked="" type="checkbox"/> Yes <input type="checkbox"/> No
Windsock condition:	<input checked="" type="checkbox"/> Adequate <input type="checkbox"/> Replace	No. marker cones required	#3
Other comments:			

² It is RAA's professional opinion that due to this specific surface condition the airstrip is non-serviceable at the time of this survey, and may not be safe for aircraft use.

5.7 Appendix G: Maintenance Manual Supplement

PACIFIC AEROSPACE

750XL MAINTENANCE MANUAL
SUPPLEMENTS

750XL

INSTRUCTIONS FOR CONTINUED AIRWORTHINESS MAINTENANCE MANUAL SUPPLEMENT

MODIFICATION PAC/XL/0663 RETROFIT MLG ATTACHMENT BOLTS – 7/16”

LIST OF EFFECTIVE PAGES (Issue 2)

Page No.	Date
0663-1	8 April 2016
0663-2	8 April 2016
0663-3	8 April 2016
0663-4	8 April 2016
0663-5	8 April 2016
0663-6	8 April 2016
0663-7	8 April 2016
0663-8	8 April 2016
0663-9	8 April 2016
0663-10	8 April 2016

DATE OF APPROVAL: _____



INTENTIONALLY LEFT BLANK

LIFE LIMITATIONS

The Airworthiness Section is FAA approved and specifies maintenance required under Sections 43.16 and 91.403 of the Federal Aviation Regulations unless an alternative program has been FAA approved.

- (1) There are no new or additional limitations associated with this installation.

DESCRIPTION & OPERATION

(Refer to Figure 1)

Modification PAC/XL/0663 provides data required for retro fitting new larger diameter (7/16") MLG attachment bolts, replacing the existing standard (3/8") MLG Bolts.

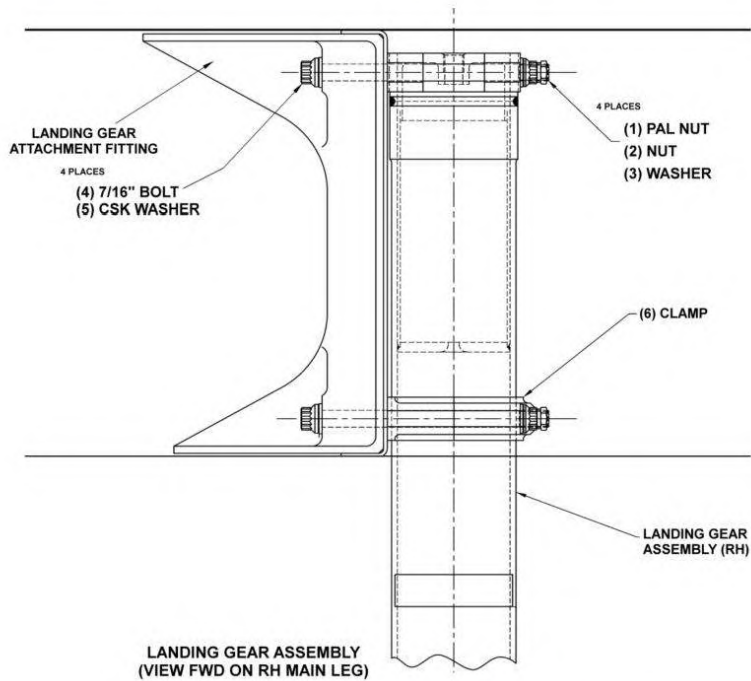

FIGURE 1 LARGER DIA. MLG BOLT INSTALLATION

MAINTENANCE PRACTICES**1. ADAPTING MLG AND ATTACHMENT FITTING**

(Refer to Figures 2 to 6)

A. MLG ATTACHMENT FITTING (11-20381-1)

Instructions are given for RH side only. Repeat instructions for the LH side as well.

- (1) Remove MLG IAW MM Chapter 32-10-00.
- (2) It will be necessary to detach and move out the way the most inboard section of the Support Strap – Upper Former (P/N 11-20291-1) and Upper Former - Wing (P/N 11-20163-1) in the location of the Attachment Fitting. To do this the AN3 bolt that attaches the Support Strap to the MLG Attachment Fitting will need to be uninstalled and the relevant rivets drilled out for these parts. Ensure all the rivet tails are collected.
- (3) Drill out the MLG attachment bolts to 7/16" diameter as follows:
 - (a) Locate using the smaller diameter end of the indexing pins, install the jig Base Plate (1) into the MLG fitting (2), with the Ident stamp 'A' facing out.

NOTE: Due to the space envelope available it is necessary to use a 90° 3/8th chuck Drill.

- (b) Install Pilot Hole Drill Bush (3) onto the Pilot Drill Bit 27/64". The Pilot Hole Drill Bushes are identified by 1 groove as a marker.
- (c) Insert the Drill through the Trailing Edge Access Panel and open holes to 27/64" using a good supply of Metal Cutting Lubricant. Clean swarf from the hole while drilling and reaming.

WARNING: DO NOT ALLOW THE TEMPERATURE OF THE BASE METAL TO EXCEED 100°C DURING MACHINING. MEASURE TEMPERATURE USING A DEVICE SUCH AS AN INFRARED HEAT GUN.

- (d) Using a 27/64" drill, bore out the pilot holes.
- (e) Remove Qty 2 Pilot Hole Drill Bushes (3) from jig Base Plate (1).
- (f) Install Qty 2 Ream Hole Drill Bushes (4) into the Base Plate (1). These bushes are identified by 2 grooves as a marker.
- (g) Ream out the attachment bolt holes using a 7/16" Reamer to a tolerance of dia. 0.4365"/0.4375".
- (h) Using the Tyrapp handles (5), remove Base Plate (1).
- (i) Reverse the Base Plate (1) and refit into the MLG attachment fitting (2), with the Ident stamp 'B' facing out and the larger diameter ends of the Indexing Pins are installed in the larger diameter bolt holes.
- (j) Repeat steps (2)(b) through (2)(f) drilling out the remaining two bolt holes.
- (k) Remove the Base Plate (1).
- (4) Remove the drill jig. Vacuum out all the swarf from the bolt holes and the wing bay areas and clean up any excess Cutting Fluid / Paste
- (5) Inspect the drilled holes to ensure all swarf / chips are removed and the hole diameters meet the required tolerance
- (6) In order to reattach the Upper Former - Wing (P/N 11-20163-1) and the Support Strap – Upper Former (P/N 11-20291-1) back into their respective locations, the rivet holes need to be drilled out to 5/32 diameter.

- (7) Using Cherry Max rivets CR3213-5-2, rivet the Upper Wing Former back onto Upper Skin. Using a Cherry Max rivet, reattach the Support Strap to the Former. Reattach the Support Strap to the MLG Wingbox bulkhead using the existing hardware (AN3 bolt, AN960-10 washer and MS21044N3 nut).

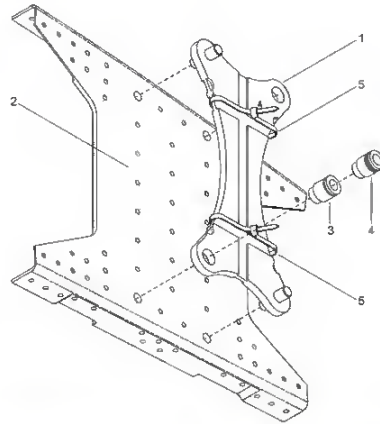

FIGURE 2 ATTACHMENT FITTING ADAPTATION



FIGURE 3 SUPPORT STRAP AND UPPER WING FORMER REMOVED

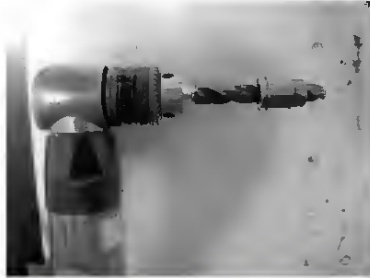

FIGURE 4 DRILL BUSH, STEP 3B

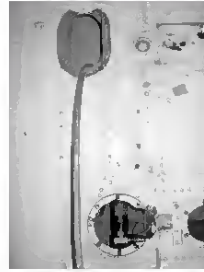

FIGURE 5 WING ACCESS PANELS

B. ADAPTING THE MLG CYLINDER

(Refer to Figure 6)

- (1) With the MLG assembly removed from the aircraft disassemble IAW MM Chapter 32-10-00 as required to enable machining of the Cylinder.
- (2) Mill out the in-step on the MLG Cylinder IAW Figure 6 (Detail 'A') below.

WARNING: DO NOT ALLOW THE TEMPERATURE OF THE BASE METAL TO EXCEED 371°C (TEMPERING TEMPERATURE LIMIT) DURING MACHINING.

- (3) Drill and ream Qty 2 holes through the top of the MLG Cylinder Assembly to a tolerance of 0.4365" / 0.4375" using a Drill Press, or equivalent suitable tooling (IAW Figure 6 Detail 'B').

NOTE: Due to the material hardness it may be necessary to use bench machinery for this purpose as opposed to hand drilling using a Drill Block, or equivalent.

MLG Cylinder 11-40061-2 is available from PAL as an alternative to adapting the existing cylinder to match the 11-40061-2 configuration.

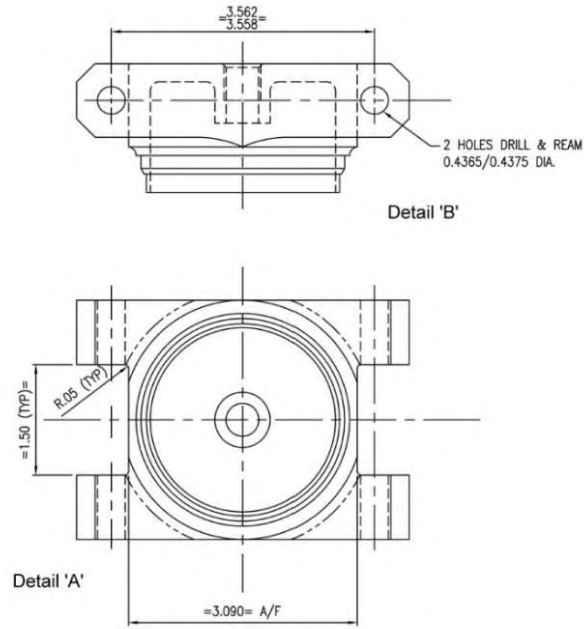

FIGURE 6 MLG CYLINDER ADAPTATION

REMOVAL & INSTALLATION

1. MLG INSTALLATION

(Refer to Figures 1 & 7)

Install the MLG IAW 32-10-00, with the following exceptions:

- (1) All Nuts (2) must be torqued to 500 in.lb. (includes friction drag torque) while holding Bolts (4).
- (2) Hardware to be used is IAW Table 1.

Item	Description	P/N	Quantity
1	PAL Nut	MS27151-21	4
2	Nut	NAS1804-7	4
3	Washer	AN960-716	4
4	Bolt	MS21250-07078	4
5	Washer - CSK	MS20002C7	4
6	Clamp Landing Gear	11-40083-1	1
7	Cherry Max rivet	CR3213-5-2	34 (+4 spare)

TABLE 1 INSTALLATION HARDWARE

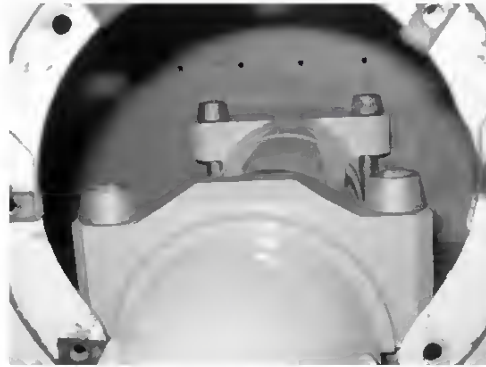

FIGURE 7 MLG NEW HARDWARE

INSPECTION & TEST

1. MAINTENANCE SCHEDULE

The following schedule (including time limits) has been prepared to maintain the aircraft in an airworthy condition and is recommended as a guide to enable operators to raise their own inspection schedules within the framework laid down by the appropriate Civil Airworthiness Authority.

This inspection schedule is to be carried out in conjunction with the operators approved Maintenance inspection schedule

SYSTEM/STRUCTURE	LANDING GEAR	FREQUENCY	ENG/ MECH	INSP	SPECIAL REQUIREMENTS AND REFERENCES
CHAPTER REF	32	CHECK NO.			
ITEM	OPERATION	1	2		
MLG	a) Examine attachment bolts for security, condition and distortion	*			
	b) Remove Pal Nut. Check Torque for attachment bolts and reinstall Pal Nut	*			500 In lb Torque

Ref. MAINT. SCH

ENG/MECH = Engineer/Mechanic INSP = Inspector

CHECK 1 = 150 HRS CHECK 2 = 300 HRS

NOTE 1: These times do not supersede any minimum inspection schedule requirements determined by the appropriate local Civil Airworthiness Authority where the aircraft is registered

NOTE 2: For U.S. operations, per 14 CFR Part 91.409, no person may operate an aircraft unless within the preceding 12 months it has had an annual inspection

INTENTIONALLY LEFT BLANK

5.8 Appendix H. Accidents at rural airstrips and the geographical locations of the airstrips.

